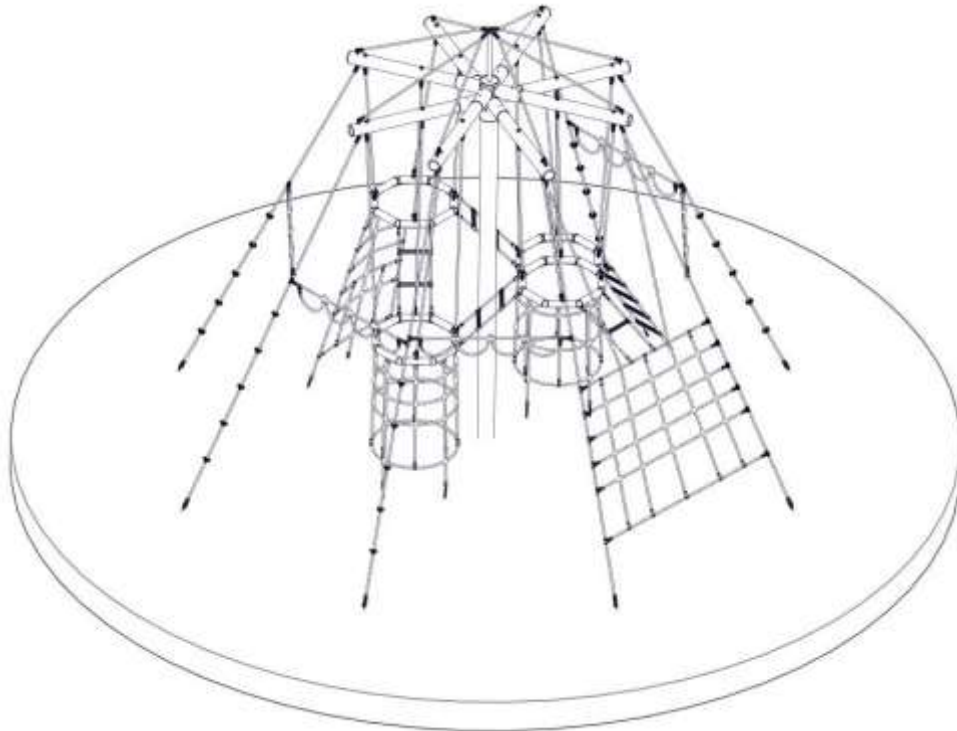

A Assembly instructions

Bird's nest tree

Art. 4652S

Attention! Only use the assembly instructions included in the scope of delivery for the assembly, installation and maintenance of the respective equipment!



Operator: _____

Location: _____

Revision history

Revision 0 – 2010-09-16

The first allowed version

Revision 17 -2024-05-02

S12 Abkürzung LE +SE Mo hinzugefügt

S 24 Ansicht ergänzt

Assembly instruction

All rights reserved

© Copyright 2010 Huck Seiltechnik GmbH

Contents

A	Assembly instructions Bird's nest tree Art. 4652S	1
1	Introduction Assembling	4
2	Datasheet Bird's nest tree, article 4652S	6
3	Delivery contents (parts list with part numbers)	8
4	Abbreviations	12
5	Assembly instructions	14
6	Post installation checks	26
B	Maintenance instructions Bird's nest tree Art. 4652S	27
7	Introduction Maintenance	29
8	General maintenance information	30
9	Maintenance timetable	32
10	Regular maintenance	33
11	Monthly maintenance	34
12	Quarterly maintenance	34
13	Half yearly maintenance	35
14	Annual maintenance	35
15	Maintenance printout	37
16	Hand over document	39

List of Tables

Table 3-1: Delivery contents, in words	8
Table 3-2: Delivery contents, in symbols	9

1 Introduction Assembling

1.1 General information

This equipment should be installed, inspected, maintained and operated in accordance with EN1176-7 guidelines.

Before installation work commences, please check that you have all of the equipment and fixation components in the parts list provided (see Tables 3-1 and 3-2).

Please consider that the installation has to be carried out only on even terrain (max.slope up to 3%).

Any spare parts that may be required can be obtained directly from your supplier.

Please do not hesitate to call your supplier if you have any problems during installation or in case of any other questions.



Attention

Following installation, complete assembly instructions, maintenance instructions and a maintenance record must be sent to the operator who must confirm receipt in writing. See the last page of this document.



Attention

All nuts and bolts are hot-dip galvanised or stainless steel.

One of the characteristics of stainless steel is that uncontrolled cold-welding may occur when the nuts are tightened. To prevent this, it is necessary to spray the nuts and bolts with Teflon spray or another similar lubricant.

We hereby confirm that this play equipment has been tested and certified in accordance with the play equipment standard EN 1176.

Drawings / Views

All optical drawings are showing only the measurements/dimensions and are no mandatory technical views of the complete item.

We reserve the right to change technical details of our articles which are serving for the further development of our articles and are reasonable for the customer.

Measurement tolerances

Because of the properties and characteristics of the components, minor measurement tolerances compared to the indication on the sketches are possible.

This concerns all shown measurements except the foundation measurements resp. measurements below upper edge ground level/play area.

2 Datasheet Bird's nest tree, article 4652S

1. Equipment space: Ø 7680 mm
safety zone: Ø 10160 mm
height of fall: 2800 mm
height of equipment: 5730 mm
Fall protection area: 81 m²
2. Required safety surface:

Surface material	Description mm	Minimum thickness of layer mm	Maximum height of fall mm
Topsoil grass			<= 1000*
Chipped bark	20 – 80 grain size	400	<= 3000
Wood chippings	5 – 30 grain size	400	<= 3000
Sand	0.2 – 2 grain size	400	<= 3000
Gravel	2 – 8 grain size	400	<= 3000
Other ground materials	As recommended by manufacturer		

3. Name and overall dimension of the largest component:
Steel post (1 item) length 6.20 m, ø 193.7 mm
4. Name and weight of the heaviest component:
1 pallet steel post (1 piece) approx. # kg
5. Intended age group: 6 years and over
6. **Please note that this equipment is set in concrete.**

Concrete: C25/30

Required concrete: 3.20 m³

Foundations/area to be excavated:

Top edge of concrete 400 mm below ground level

13 x 400 mm long x 400 mm wide, depth 1000 mm including 100 mm drainage

1 x 2000 mm long x 400 mm wide, depth 1000 mm including 100 mm drainage

1 x 400 mm long x 580 mm wide, depth 1000 mm including 100 mm drainage

1 x 1200 mm long x 1200 mm wide, depth 1300 mm including 100 mm drainage



Attention!

Round off foundation edges (min.R = 100 mm)! Sizes of foundations are “4-5” (natural ground).

Soil class 4: soft to medium plasticity, interleave bound, with minor portion of stone (portion < 30% with bigger diameter of 63 mm grain size).

Soil class 5 : ground with soil class 3 and 4 with big portion of stones (portion > 30% with bigger diameter of 63 mm grain size).

In case of sandy and soft soils, the surface measure of foundations has to be enlarged for about 50%!

7. Assembly time, once foundations complete: 7 hours.
Required assistance: 3 people.
8. Any spare parts which may be required can be obtained directly from your supplier
9. **We hereby confirm that this item of play equipment has been tested and certified in accordance with the play equipment standard EN 1176.**

3 Delivery contents (parts list with part numbers)

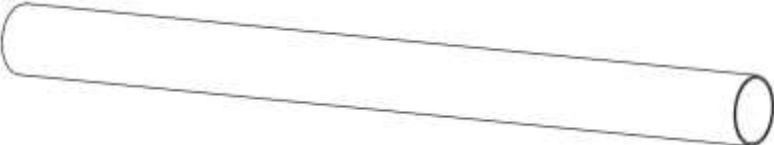
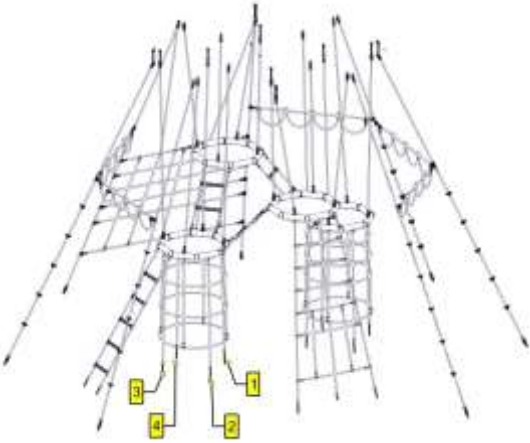
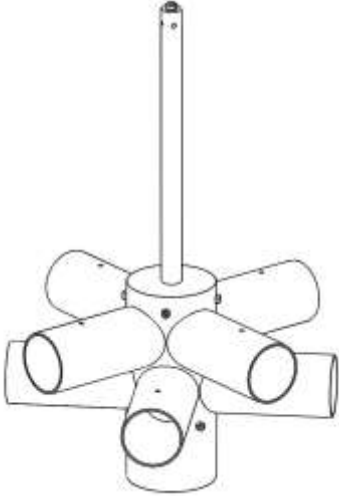
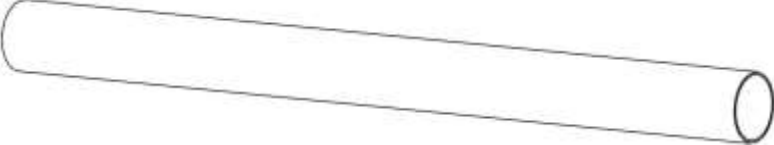
3.1 In words



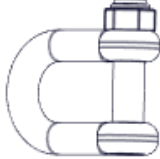

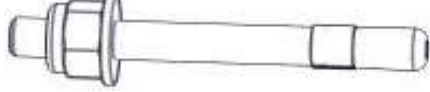
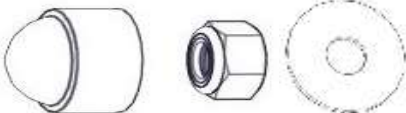


Table 3-1: Delivery contents, in words






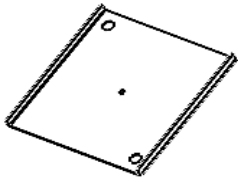



Pos.	Quantity	Element / Description	Size	O.K.	Missing
01	1	Steel post	Ø 193,7 mm / 6200 mm lg.		
02	1	Play part (nets and bird's nests)	/		
03	1	Mast cap	Ø 219,1 mm / 1240 mm lg.		
04	8	Steel cross beams	Ø139,7 mm / 1650 mm lg.		
05	4	Top rope for steel cross beams (pre-assembled on Pos. 03)	1850 mm lg.		
06	1	Flag / blue + threaded bolt + 1x nut + 1x Self-securing nut + 1x Cap (black)	M16		
100	3	Shackle	M6 / VA		
101	20	Chain adapter (stainless steel)	M12		
102	20	Fix anchor	M12		
103	17	nyloc nut + washer + black cover cap	M12		
104	8	Ring nut (1x pre-assembled)	M12 / VA		
105	8	Post end caps	Ø 139 mm		
106	24	Self drilling screw	5,5 x 25 mm		
107	8	Threaded bolt + 2x acorn nut + 2x washer	M10 x 175 mm / VA		
108	3	Loctite	3 ml		
109	8	Hexagon socket screw with flat point	M12 x 25 mm		
112	1	anchor plate + Eye bolt M16x25 + nut M16	500 x 500 mm / verz.		
113	17	Washer (1x pre-assembled)	M12		
KNR	1	PVC pipe (Provided by customer)	Ø400 / 850 mm lg.		

3.2 In symbols

Table 3-2: Delivery contents, in symbols

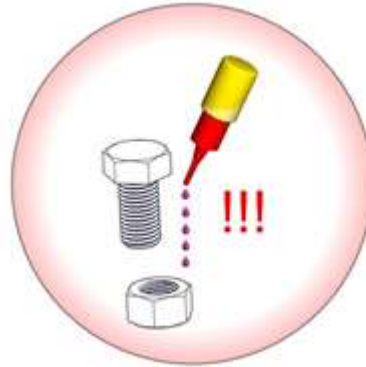
Pos.	Quantity	Symbol
01	1	 <p data-bbox="756 658 1139 694">Ø 193.7 mm / 6200 mm lg.</p>
02	1	 <p data-bbox="735 1178 1161 1214">Play part (nets and bird's nests)</p>
03	1	 <p data-bbox="756 1753 1139 1789">Ø 219,1 mm / 1240 mm lg.</p>
04	8	 <p data-bbox="756 1955 1139 1991">Ø 139.7 mm / 1650 mm lg.</p>

Pos.	Quantity	Symbol
05	4	 <p>1850 mm lg. (pre-assembled on Pos. 03)</p>
06	1	 <p>M16</p>
100	3	 <p>M6</p>
101	20	 <p>Chain adapter (stainless steel) M12</p>
102	20	 <p>M12 Fix anchor</p>
103	17	 <p>M12</p>
104	8	 <p>M12 (1x pre-assembled)</p>
105	8	

Pos.	Quantity	Symbol
		Ø 139 mm
106	24	 5,5 x 25 mm
107	8	 M10 x 175 mm
108	3	 3 ml
109	8	 M12 x 25 mm
112	1	   RS M16 x 25 500 x 500 mm Sechskantmutter M16
113	17	 M12 (1x pre-assembled)
KNR	1	 Ø400 / 850 mm lg.

4 Abbreviations	
AB	The legally prescribed setting deadlines must be observed!
D	C25/30 concrete (for foundations) Q.ty required: 3.2 m ²
D.be.	Fill in around the central mast with concrete. (between drainage tube and central mast)
DT	Detail
EDF	turn the ground anchor in to foundation / don't press
F	Fall protection
FOU	Foundation
G	Drainage layer
HK.entf.!!	Remove wooden wedges after concrete work
KELA	Chains should be shortened during installation if necessary.
KNR	Drainage tube (e.g. concrete or PVC duct, Ø 400 mm / lg. 850 mm on site)
1 – 4 KS	Position numbers of the chimney ropes for the foundation
MEb	Pay careful attention to mark when mounting the post.
MKe	Insert the mast into the drainage tube
O.K	Top surface of playing area
MSE	After mounting the steel post and the glue-laminated beams, the ropes must first be hooked in
O.K.	Top edge play level
O.K.F.	Top edge foundation
OAZ	The opening must be show outwards / not in tensile direction
PNU	Lay the net-part packet with the underside around the mast.
PS	Minimum safety area 81 m ²
SSch	After putting on the post-cap, grease the hexagon-screw and tight up.
SE Mo	Fitting the rope
Le Mo	Installing the ladder
UEA!	Smooth out any unevenness in the foundation that occurs when screwing in the ground anchor. Otherwise a water accumulation develops
	Sizes of foundations are "4-5" (natural ground Soil class 4: soft to medium plasticity, interleave bound, with minor portion of stone (portion < 30% with bigger diameter of 63 mm grain size) Soil class 5 : ground with soil class 3 and 4 with big portion of stones (portion > 30% with bigger diameter of 63 mm grain size) In case of sandy and soft soils, the surface measure of foundations have to be enlarged for about 50%!

Securing bolts and nuts!

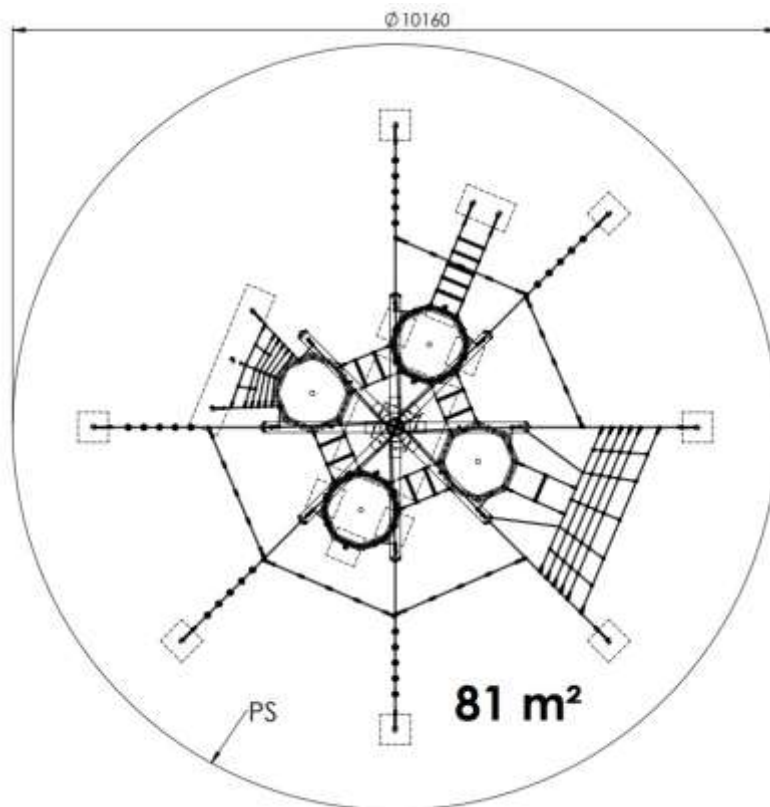
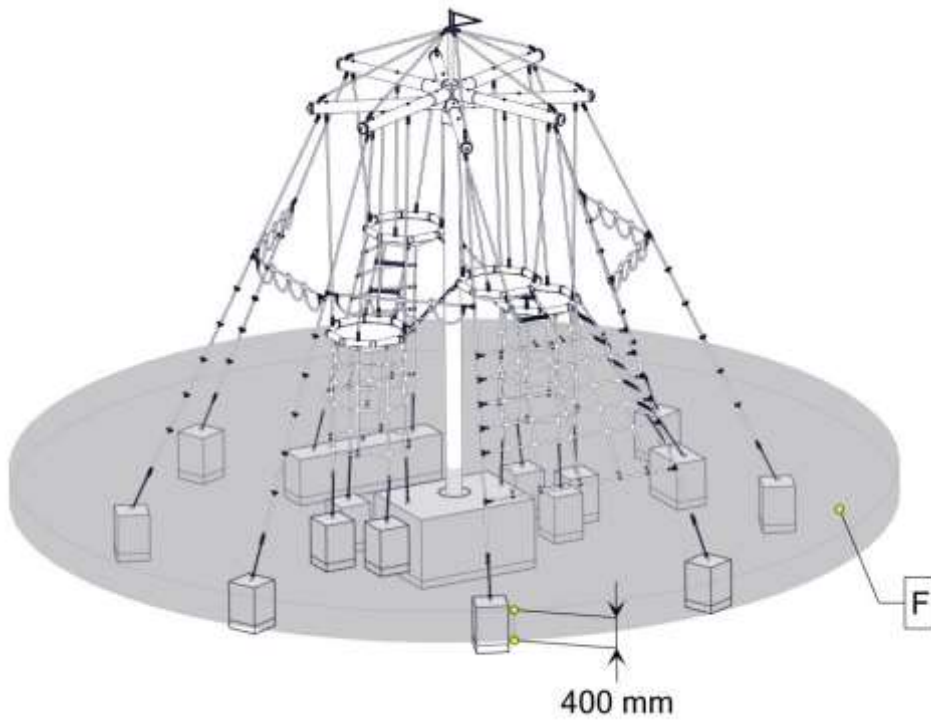


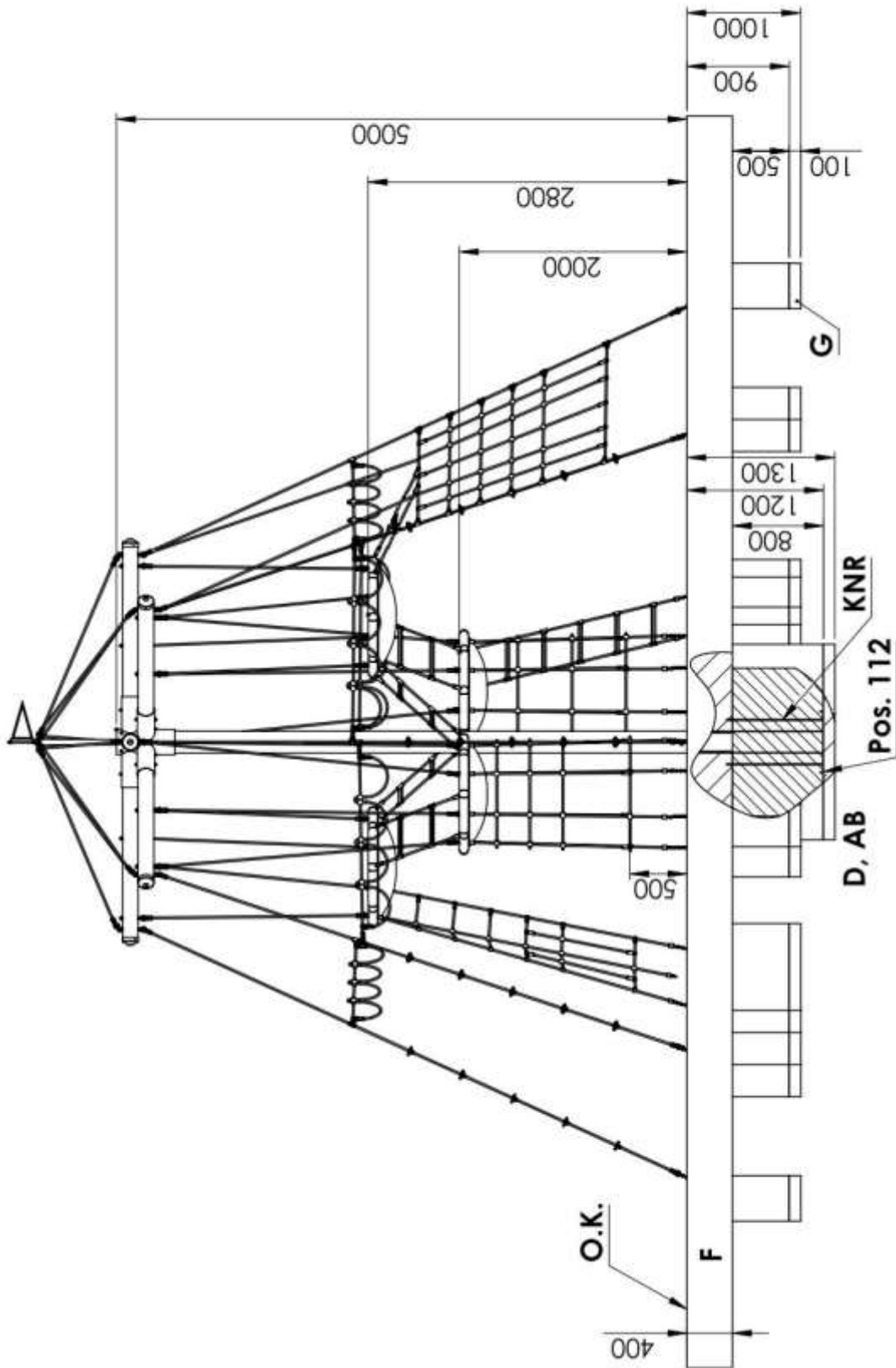
Alle bolts, nuts, etc. must be secured

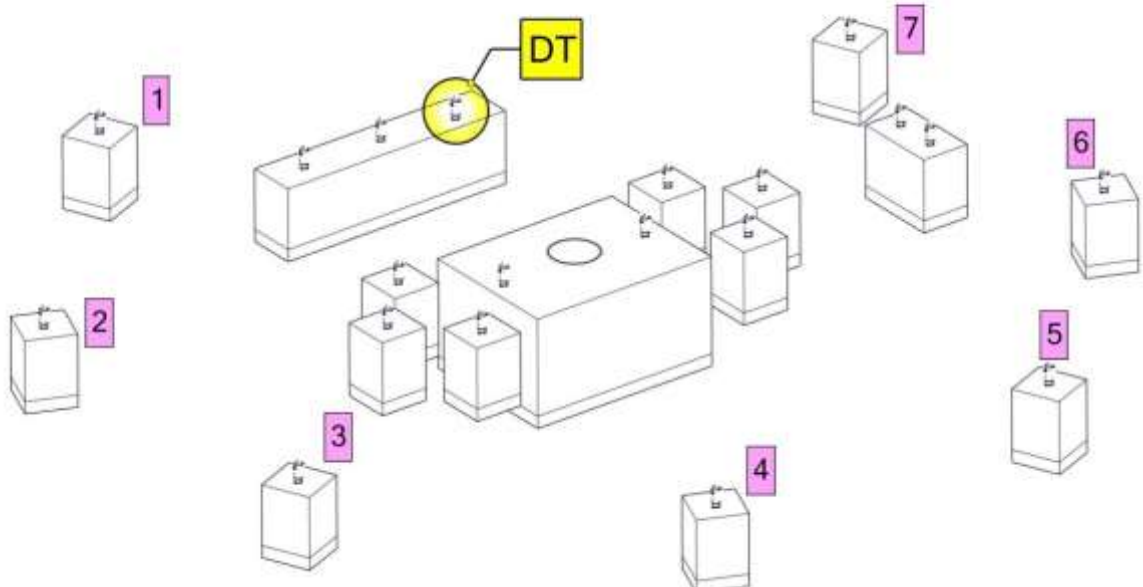
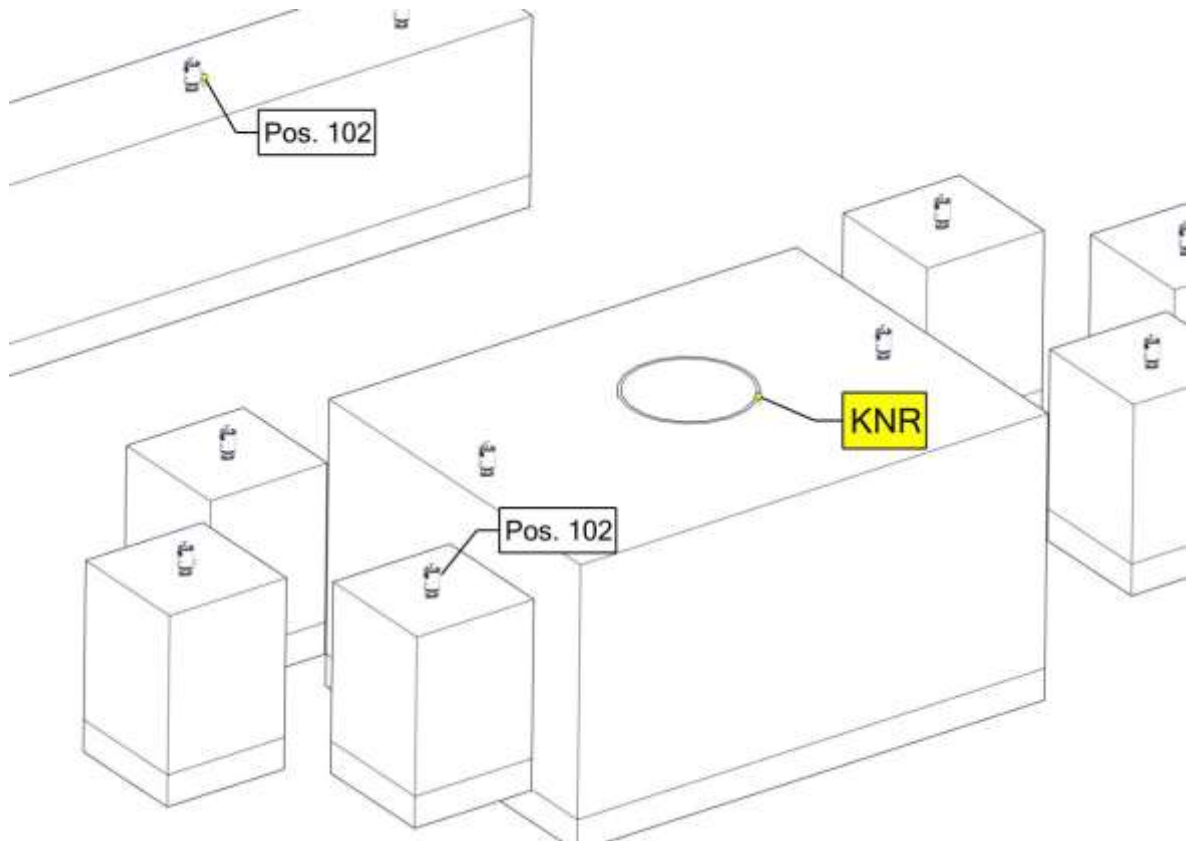
With at least 5 drops of Loctite!

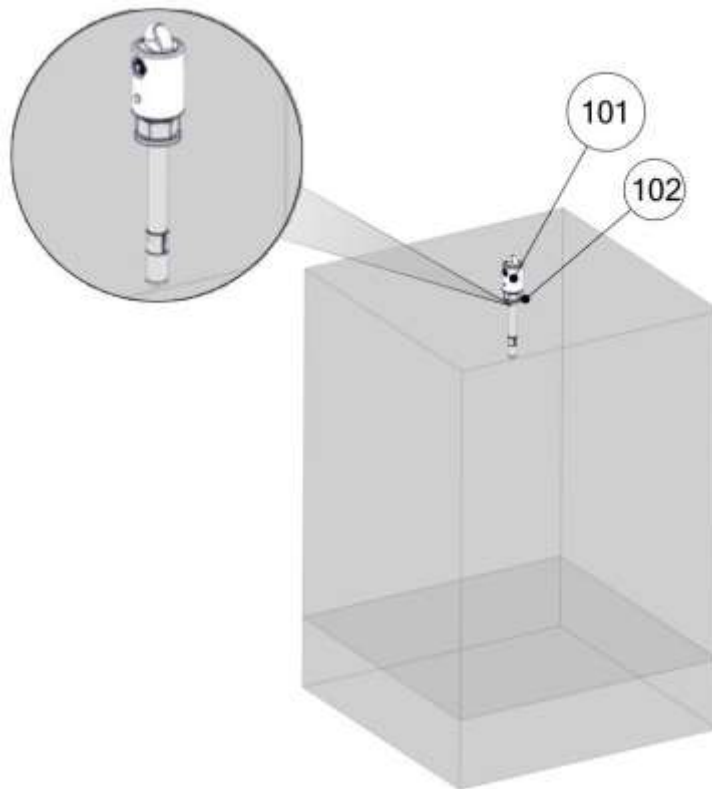
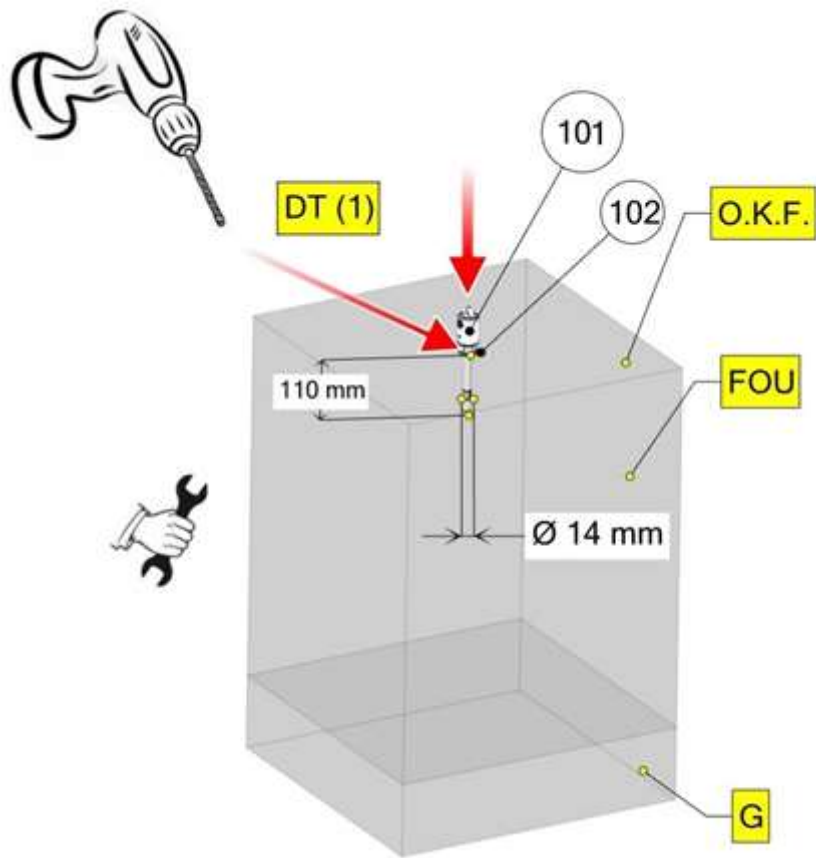
(except for Nyloc nuts)

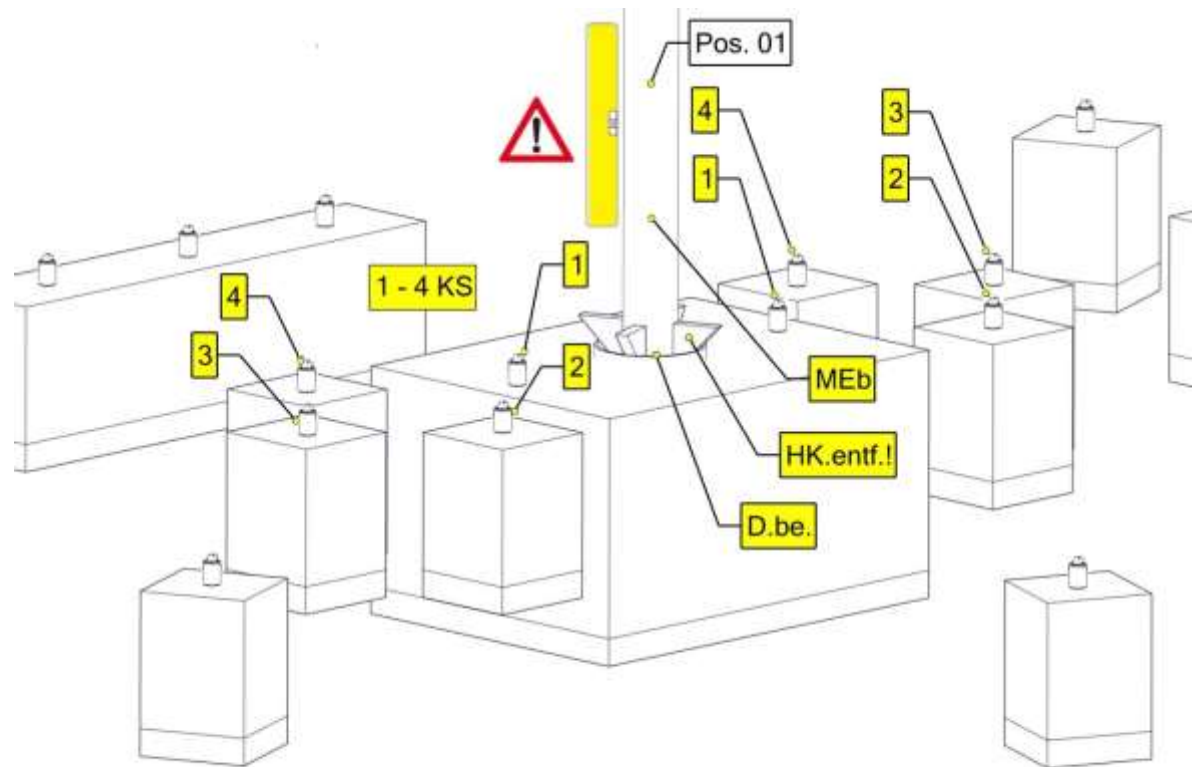
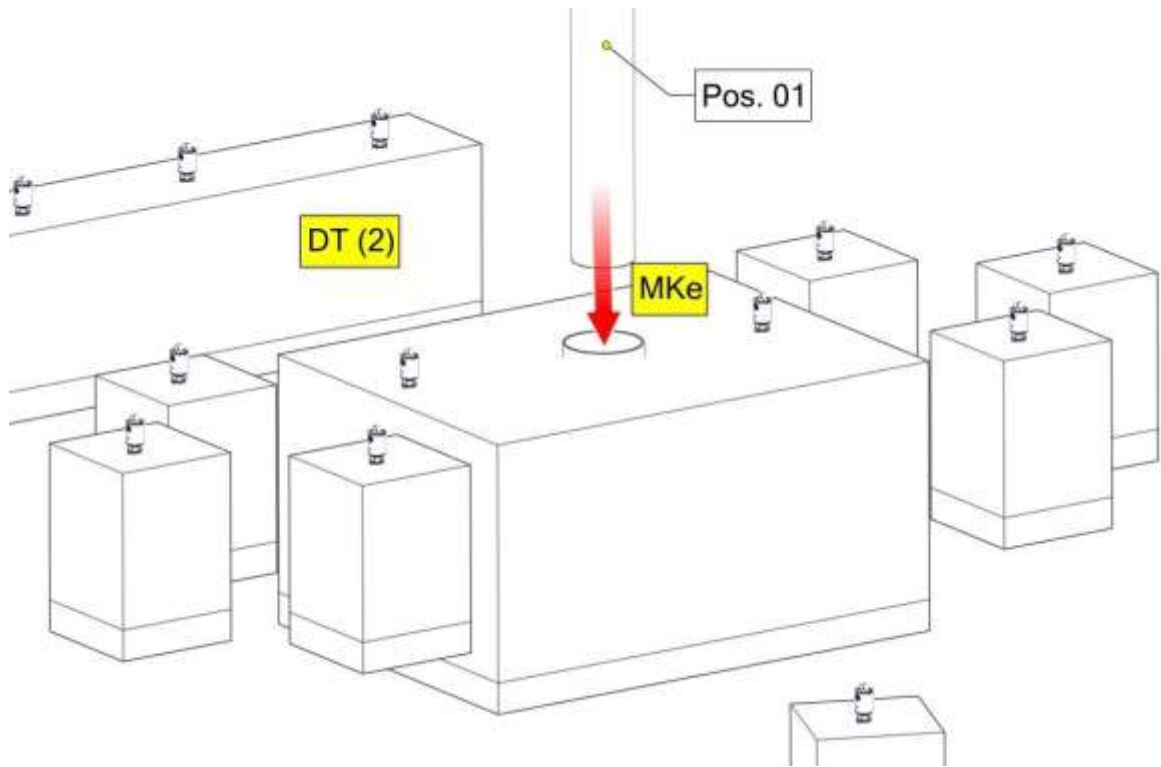
5 Assembly instructions

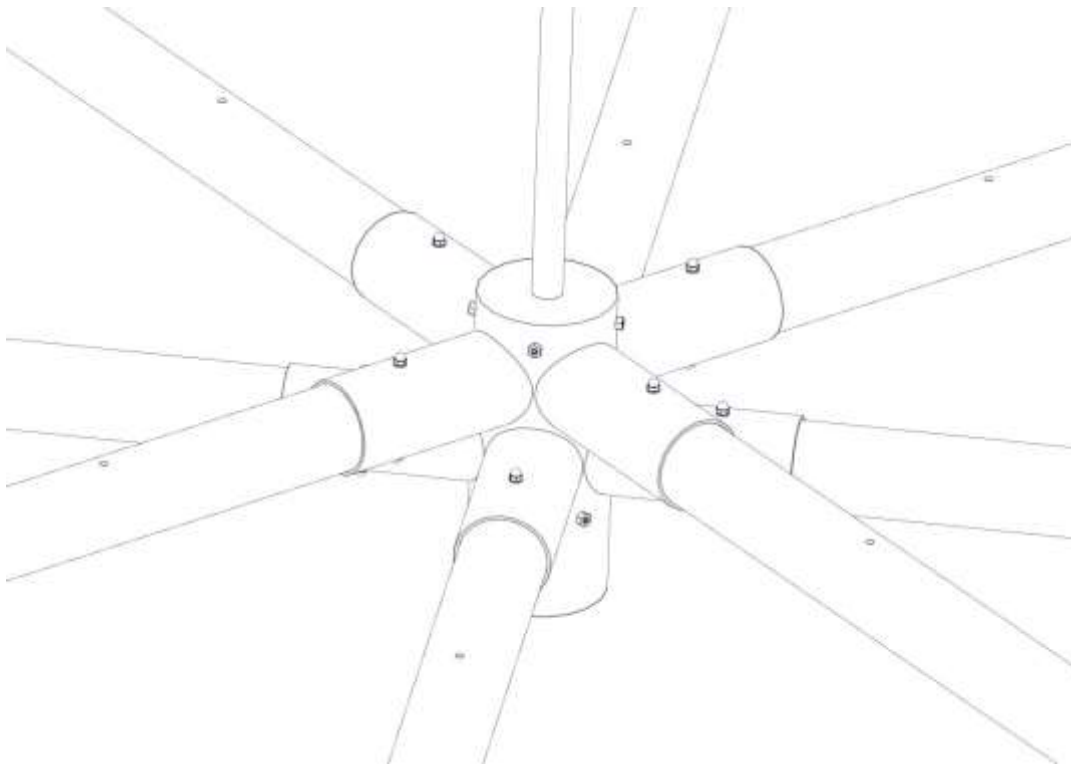
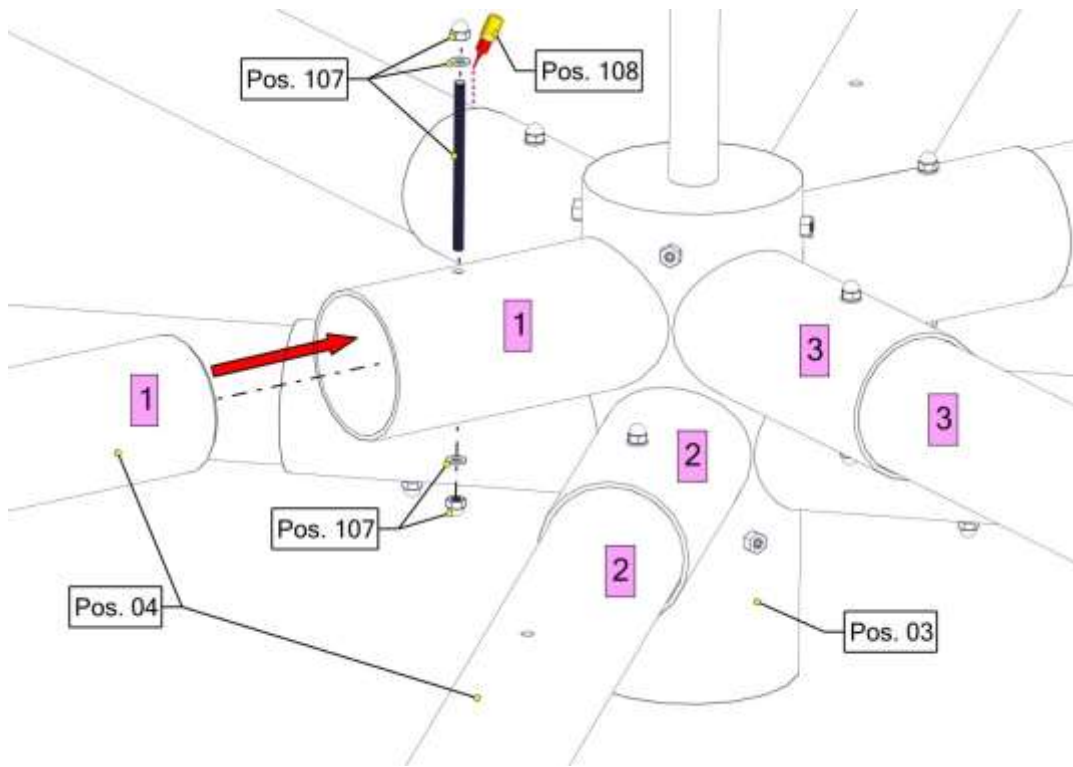


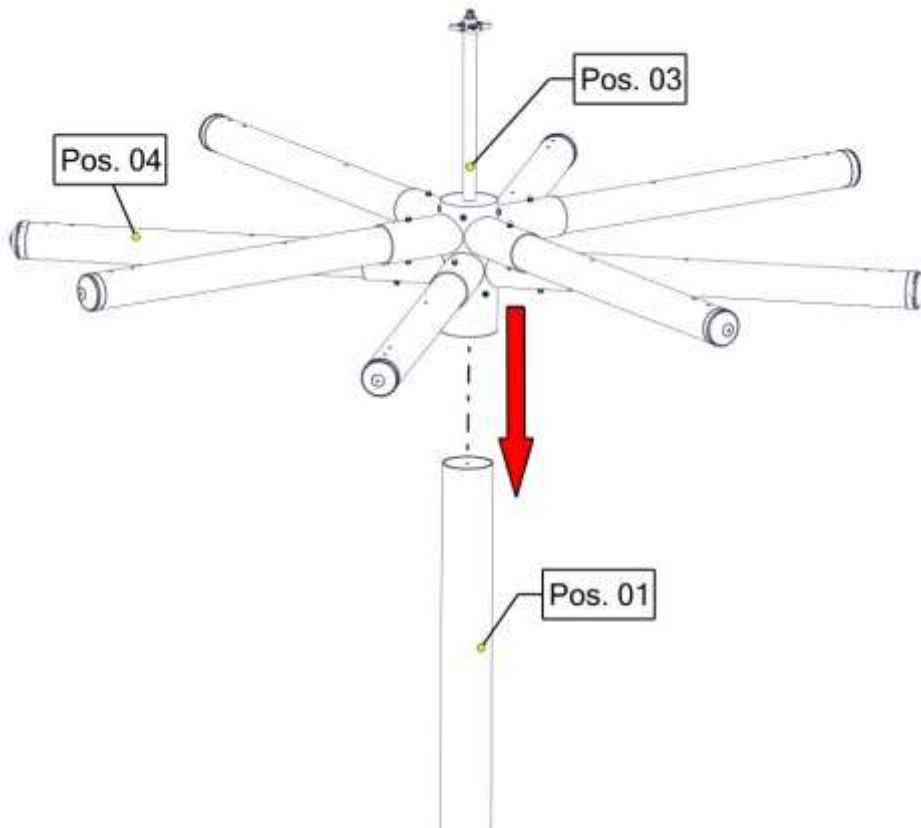
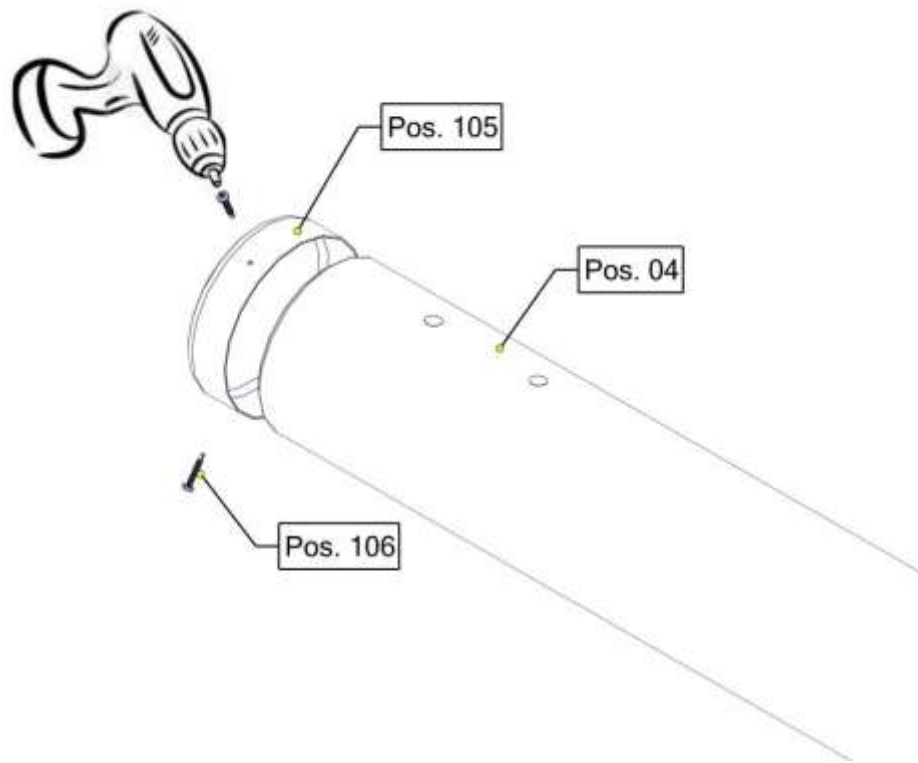


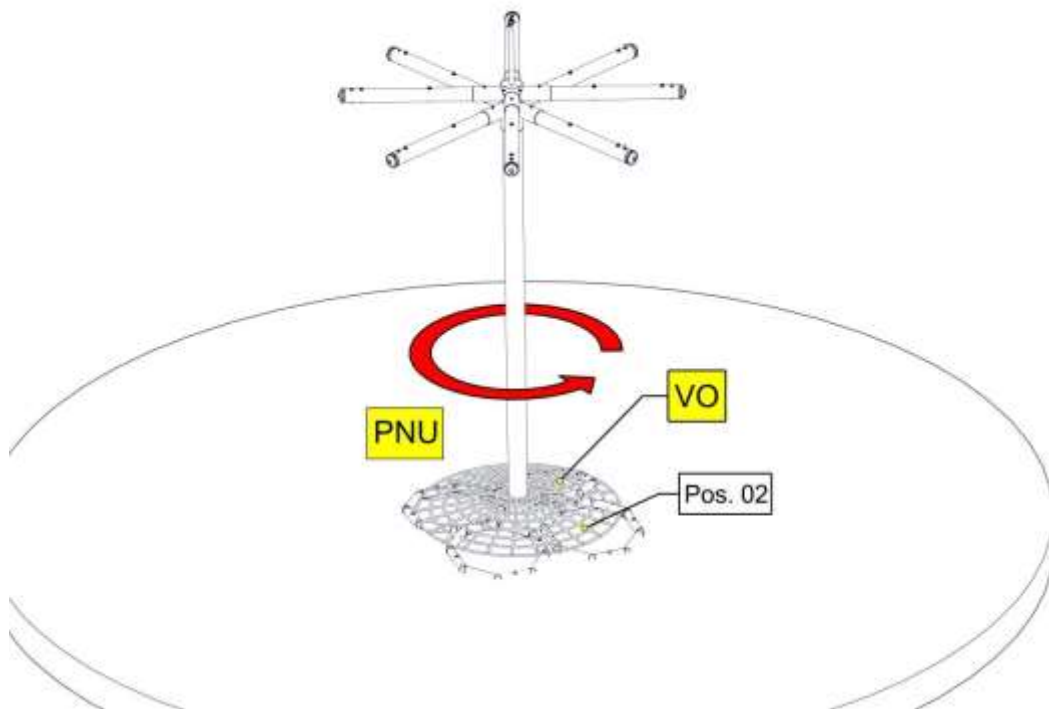
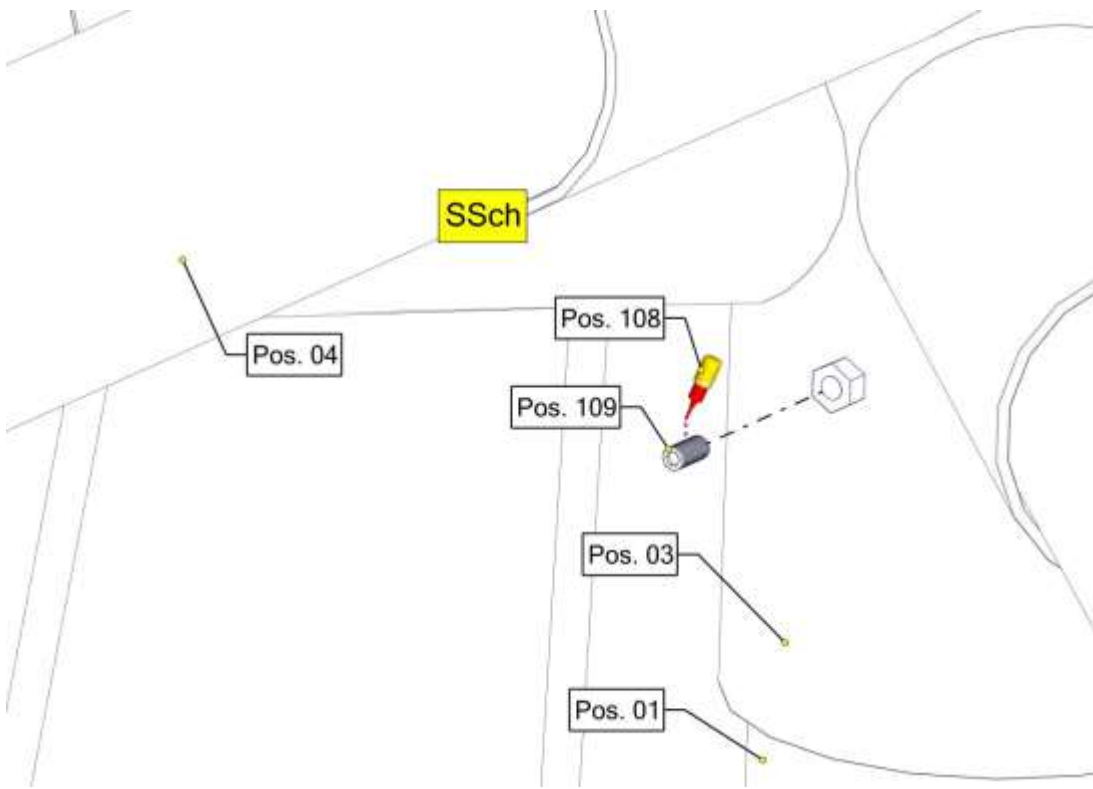


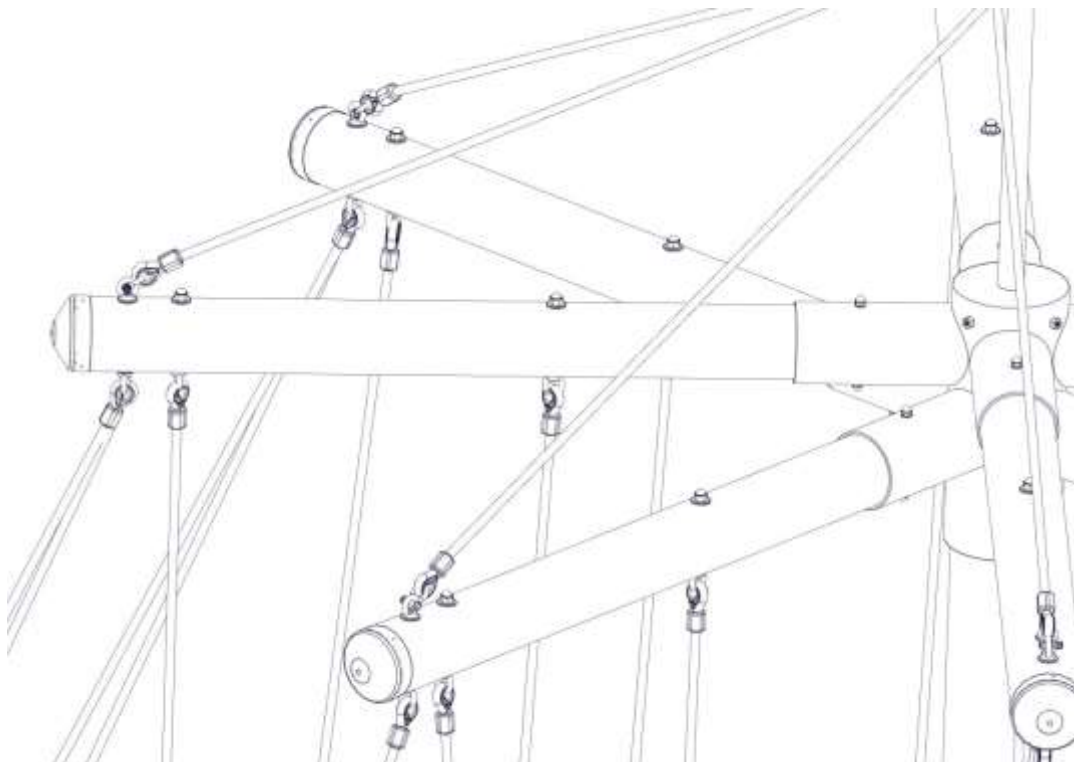
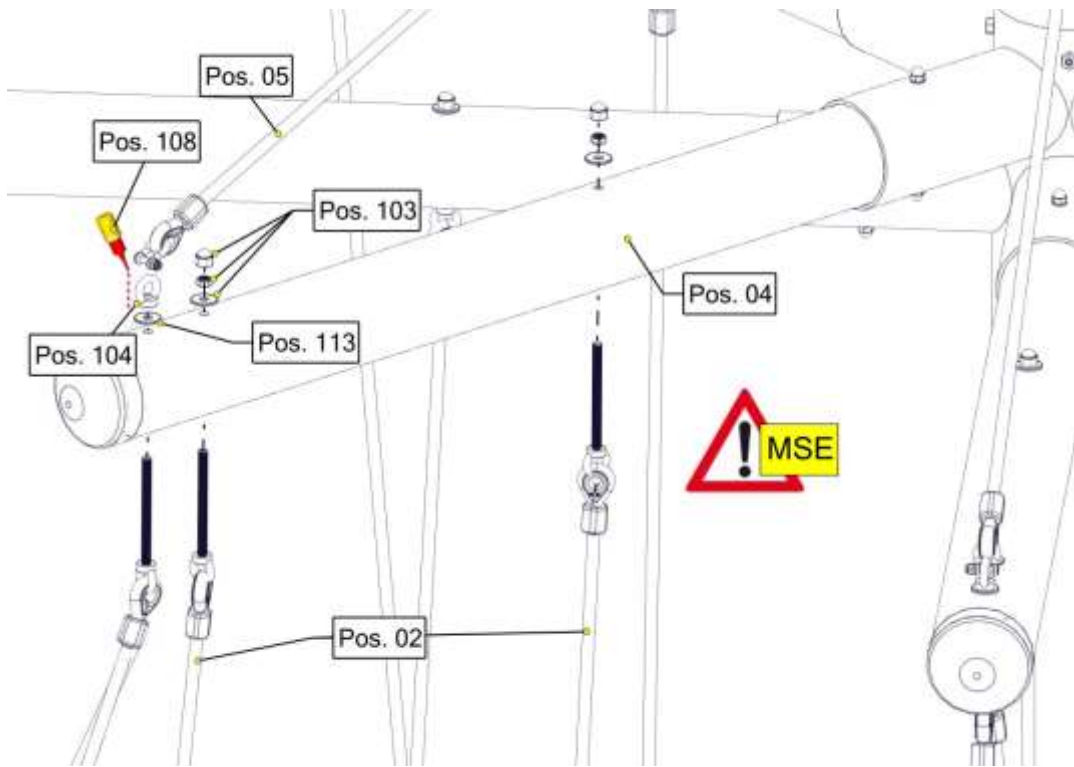


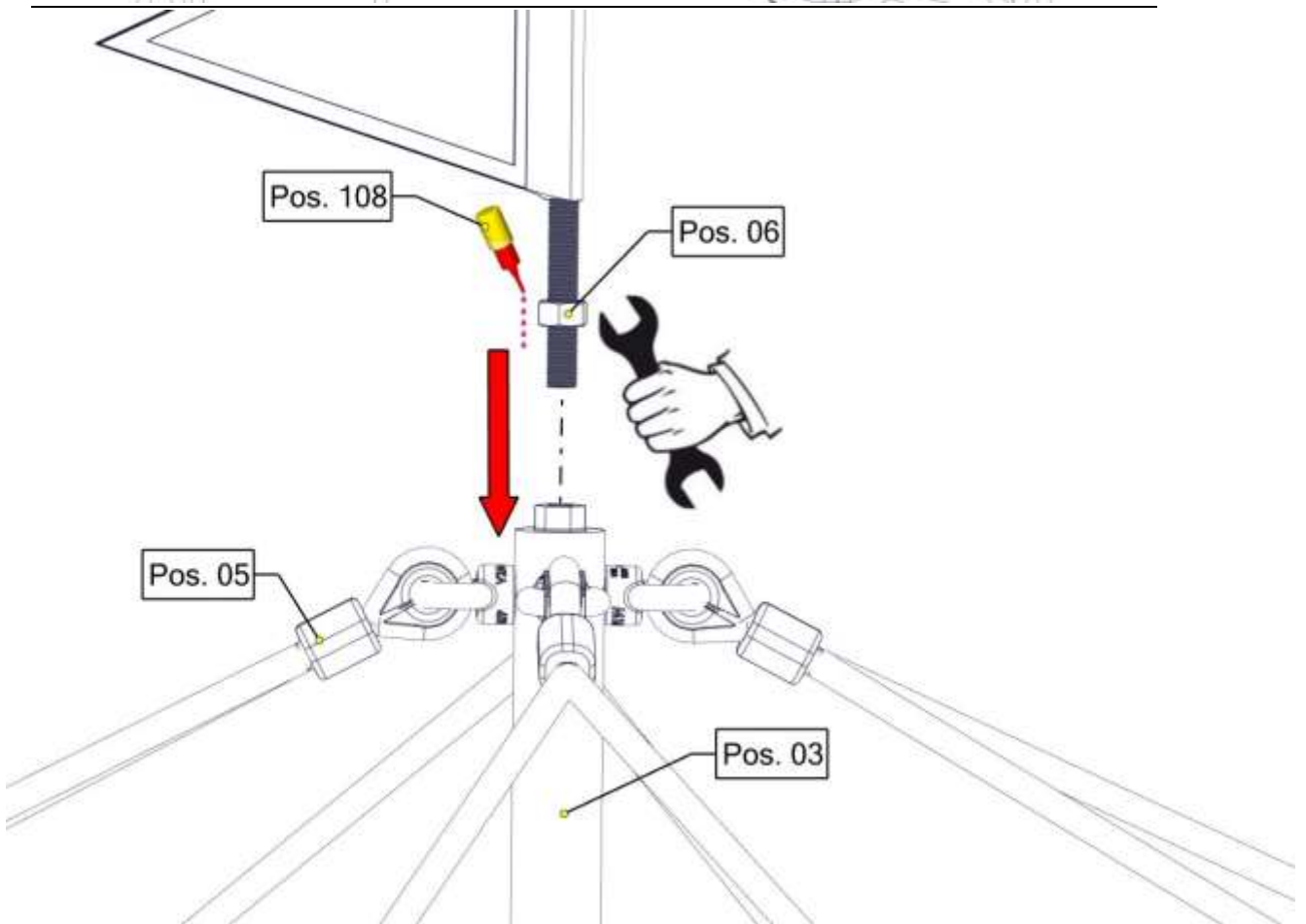
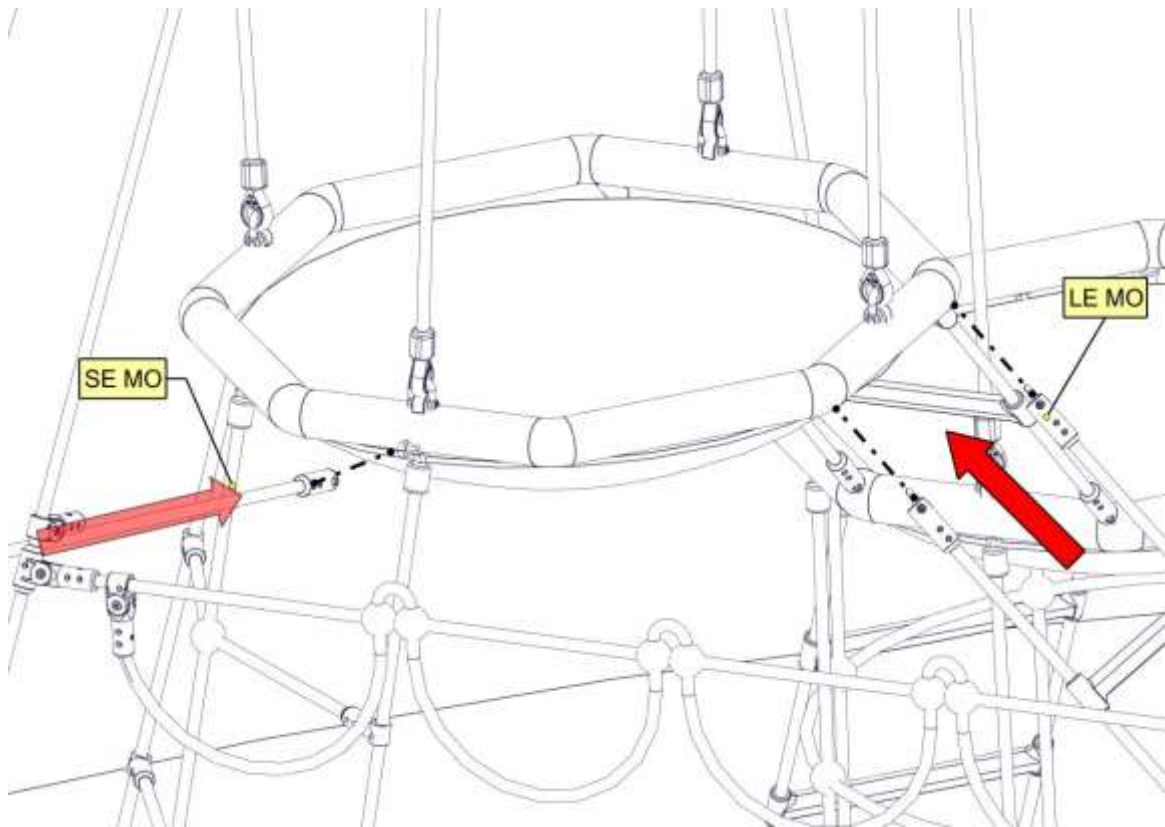


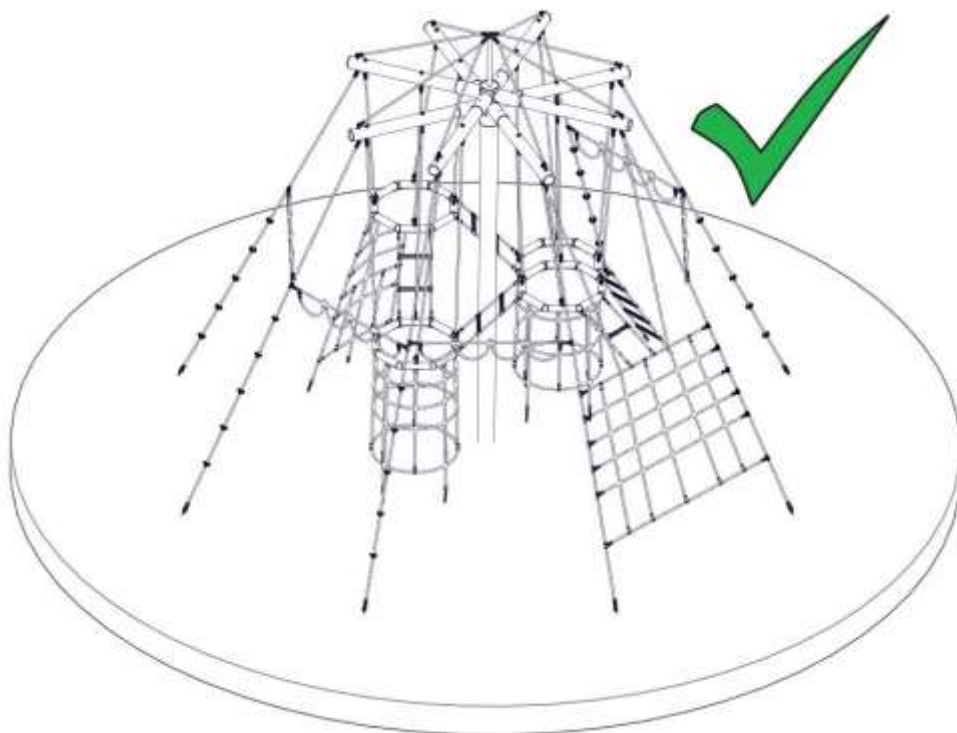
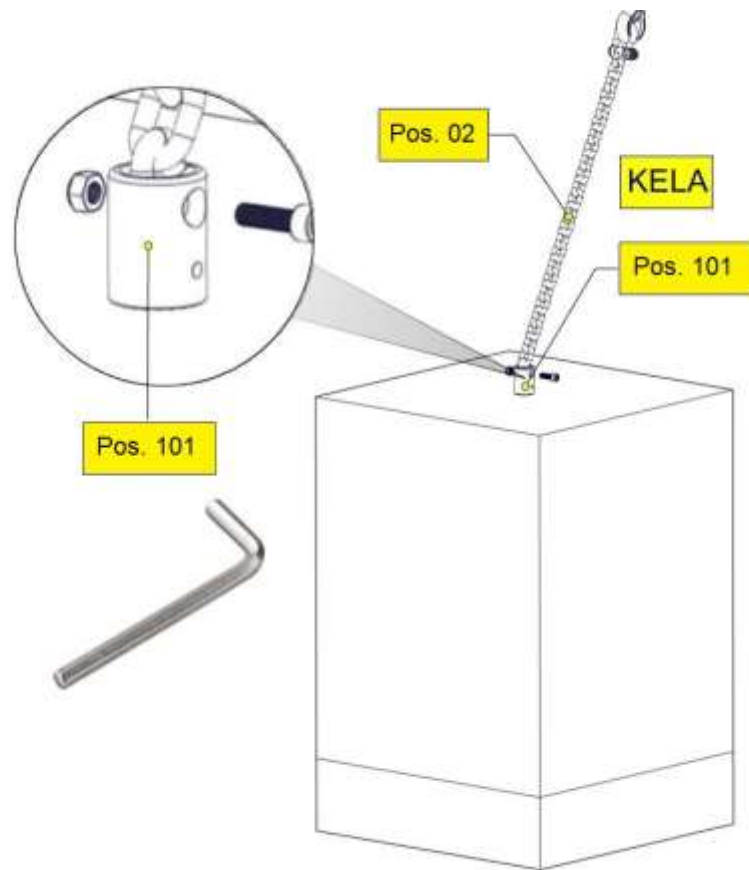












6 Post installation checks



If the equipment has not been installed safely, you must ensure that the public is prevented from using it.

6.1 Marking filler depth

- Labelling the posts to show the depth of material provided as fall protection (i.e. loose filler).

6.2 The equipment has not been installed safely in the following cases:

- Safe equipment installation is not complete.
- The protective surface has not been installed yet.
- Appropriate maintenance work cannot guarantee operational safety.

6.3 Removal of all assembly aids

- Please make sure that all assembly aids have been removed from the playing area. The equipment must not be approved for use until this check has been made.

6.4 Information about inspection of the equipment before it is used for the first time

- There are no special inspection requirements to be met before the equipment is used for the first time.

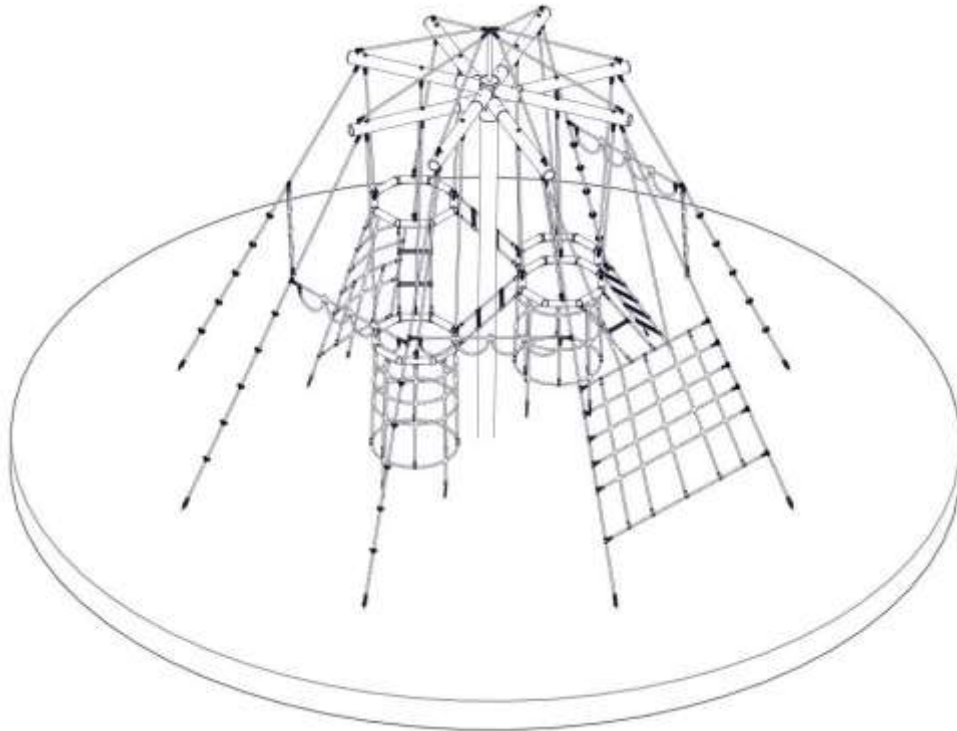
6.5 Retighten bolts

- After one week of play, please retighten all bolts again. Later upon respective maintenance.

B Maintenance instructions

Bird's nest tree

Art. 4652S



Revisionshistorie
Revision 0 – 2010-09-16
Erste freigegebene Version
Wartungsanleitung
Revision 16 -2021-06.-23
jetzt mit VA-Kettenadapter u. Fixanker M12 FH
Alle Rechte vorbehalten
© Copyright 2010 Huck Seiltechnik GmbH

7 Introduction Maintenance

7.1 General information

This equipment should be installed, inspected, maintained and operated in accordance with EN 1176-7 guidelines.



Notice

Please note: Providing any necessary repairs are carried out, a piece of play equipment that is inspected regularly cannot become so damaged that it is dangerous.

Any spare parts which may be required can be obtained directly from your supplier.



Attention

This equipment should only be assembled, maintained and repaired by **persons with the necessary expertise**.

A copy of the inspection record should be given to the operator, who must confirm receipt.

**This maintenance instruction is based on the standard
“EN 1176-1:2017”.**

8 General maintenance information

8.1 Maintenance intervals

Maintenance intervals are based on average use. Please note that more frequent inspections and/or maintenance are required if the play equipment is subject to intensive use.

8.2 Inspection frequency

The frequency of inspections must be based on actual use. Factors that affect frequency include vandalism, location (e.g. coastal proximity), air pollution and the age of the equipment.

8.3 Maintenance products and procedures

All nuts and bolts are hot-dip galvanised or stainless steel. One of the characteristics of stainless steel is that uncontrolled cold welding may occur when the nuts are tightened. To prevent this, it is necessary to spray the nuts and bolts with Teflon spray or another similar lubricant.

8.4 Spare parts

All spare parts must conform to the manufacturer's specifications.

8.5 Identifying spare parts

All spare parts are listed in the parts list. The parts list follows the installation requirements.

8.6 Special instructions for the disposal of individual equipment components

No special instructions are necessary for the disposal of individual equipment components.

8.7 Special measures during the break-in period

No later than 2 weeks after assembly, all screwed connections should be checked and tightened if necessary.

8.8 Drainage holes

All drainage holes should be kept clear.

8.9 Maintenance of protective surfaces

Surfaces providing fall protection must also be maintained regularly. It is particularly important to maintain the correct level of loose surface material and add more if necessary.

8.10 Faults



Attention

Faults must be repaired as soon as they are detected. If serious defects that compromise safety cannot be repaired straight away, the public must be prevented from using the equipment with immediate effect.

8.11 Loose screws



Attention

Loose screws always cause quality problems and put safety at risk. Therefore, loose screws should always be tightened and checks carried out to ensure that there are no missing screws (e.g. look out for holes you can see through).

8.12 Preventing equipment use

Use of the equipment should be prevented in the event of incomplete installation, disassembly, maintenance, repairs and faults.

8.13 Claims/liability for faults

Steel posts and footings are guaranteed if regular maintenance is carried out and recorded in writing. Our general terms and conditions apply. Maintenance first takes place after 3 years. The steel posts must be excavated as far as the concrete foundations and checked for corrosion.

Zinc paint should be applied to any corroded areas and scratches.

Check ropes for abrasion. Retreat any that are very worn.

9 Maintenance timetable

9.1 Special advices

9.1.1 Maintenance interval

We strongly advise you to carry out inspections and maintenance work within the specified periods as use of the equipment, the weather and malicious vandalism cause wear and tear that compromises the safety and function of the equipment.

9.1.2 Maintenance intervals in the event of intensive use

Please note that more frequent inspections and/or maintenance are required if the play equipment is subject to intensive use.

9.1.3 Faults that compromise safety



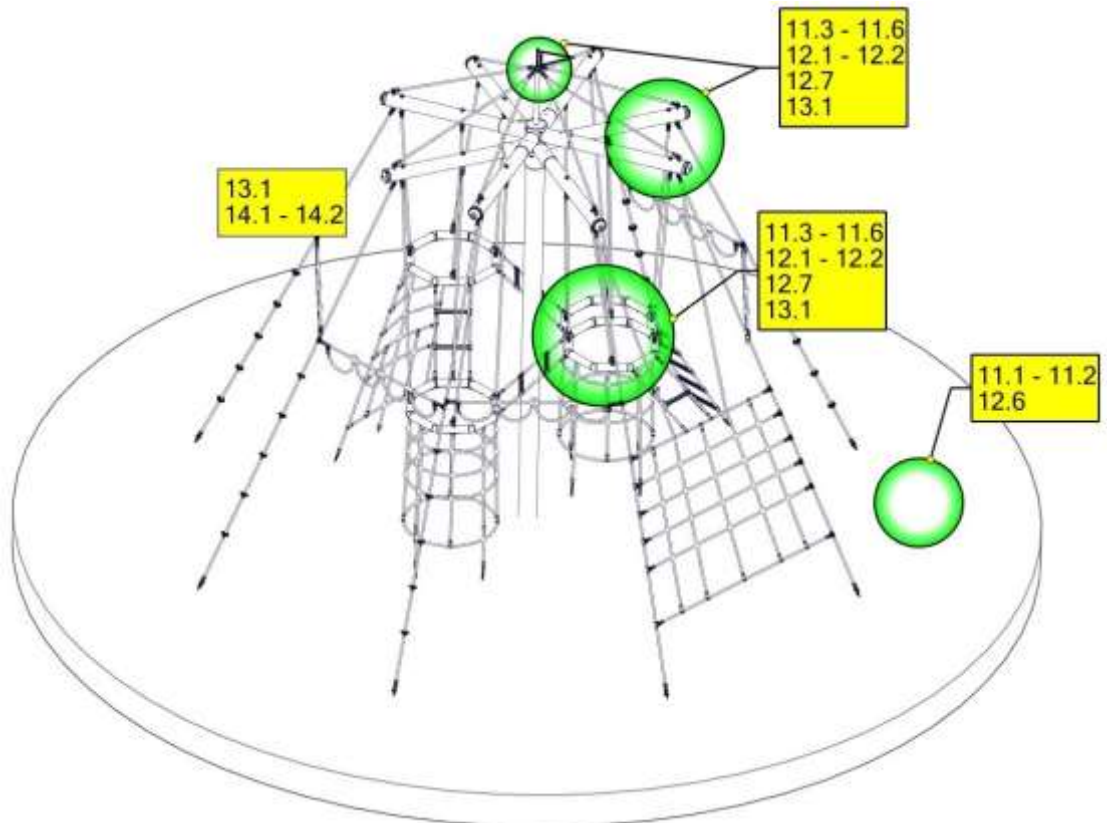
In the event of a fault that compromises safety, quick action must be taken. This may involve repairing it immediately or shutting down and dismantling the equipment.

9.1.4 Faults that compromise function



Faults that compromise function should also be repaired immediately. Such faults lower the value of the equipment to the user and encourage malicious vandalism, which may render the equipment less safe. Any damage should also be repaired immediately.

10 Regular maintenance



11 Monthly maintenance

- 11.1 Check the spaces between the equipment and the ground (clearance and height of fall).**
- 11.2 Check the ground surface in the area with fall protection for hard objects and loose foundations.**
- 11.3 Check all connecting elements and fittings for wear and tear and tighten if necessary. Replace damaged or missing parts.**
- 11.4 Check that moving metal parts (joints, springs, etc.) move smoothly and are not worn. Replace if necessary. It is not necessary to lubricate joints as we only use maintenance-free metal roller bearings.**
- 11.5 Check all attachments such as chains, ropes, nets, etc. for damage and replace if necessary.**
- 11.6 Check rubber parts, sleeves, etc. for wear and tear or damage and replace if necessary.**
- 11.7 If necessary, remove excess padding material from the post footings due to danger of rotting.**
- 11.8 Check the surface of wooden parts for damage caused by the weather or external influences and mould. Repair or replace if necessary.**
- 11.9 Check the surface of plastic and metal parts, e.g. slides, for damage and replace if necessary.**

12 Quarterly maintenance

- 12.1 Detailed inspection of the operation and stability of the equipment paying particular attention to any wear and tear.**
- 12.2 Tighten all forms of attachment.**
- 12.3 Repaint and retreat surfaces.**
- 12.4 Maintenance of fall protection surfaces.**
- 12.5 Lubrication of joints.**
- 12.6 Check the height of the fall and top up with loose filler if necessary. If the posts are labelled, top up as far as the mark.**
- 12.7 Retighten all bolts**

13 Half yearly maintenance

- 13.1 Stability (check posts, bracing, foundations, etc.).
- 13.2 Ascertaining whether there are any changes in equipment safety as a result of repairs that have been carried out or components that have been added or replaced.



Attention

Annual Maintenance

14 Annual maintenance

- 14.1 Ascertaining that the equipment, foundations and surfaces are safe for operation.
- 14.2 In particular, the equipment should be checked for decay and corrosion. It may be necessary to dig out or excavate certain components in order to do so. Zinc paint should be applied to corroded areas and scratches.



Attention

The equipment must be inspected by someone **with the necessary expertise** in strict compliance with the instructions issued by Huck Seiltechnik GmbH.

A copy of the inspection record should be given to the operator, who must confirm receipt.

16 Hand over document



After the installation of the equipment pass the installation and maintenance documents to the operator. The operator has to receive the hand over documents. The complete filled and signed hand over document should be sent to the supplier.

Art.-No.: 4652S

Type of item: Bird's nest tree

Serial number:

Customer or operator (Town, Town council, Kindergarten, etc.):

Competent person in charge:

Installation company (address):

Responsible assistant (assembler):

Received the complete assembly instructions, maintenance instructions and maintenance printout.

(Signature of operator)
(Stamp)

(Signature of installation company)

Date: _____