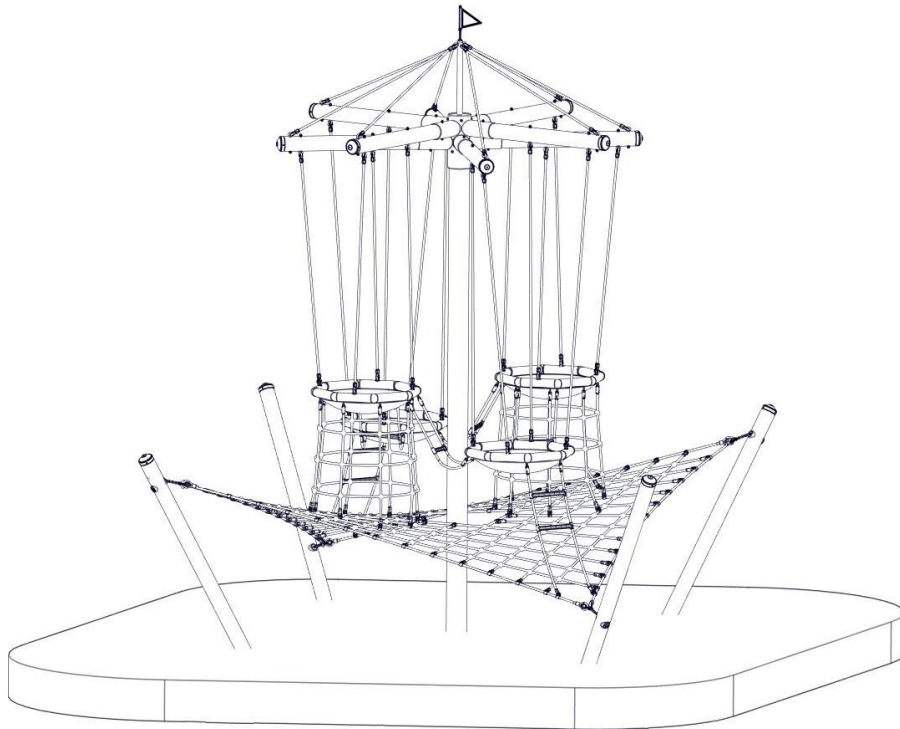


A Assembly Instructions

“Laola” bird´s nest tree, Art.-No. 4652-60

Attention! Only use the instructions included in the scope of delivery for the assembly, installation and maintenance of the respective equipment!



Operator: _____

Location: _____

Revision 0 – 2017-03-08

Erste freigegebene Version

Montageanleitung

Revision 3 – 2021-03-11

Neue Form der Montageanleitung FH

Alle Rechte vorbehalten

© Copyright 2017 Huck Seiltechnik GmbH

**Please note the explanations and abbreviations and notes.
For any queries please contact the manufacturer**

Contents

A	Assembly Instructions 4652-60	1
1	Introduction Assembling	4
2	Datasheet: 4652-60	6
3	Delivery contents (parts list with part numbers)	8
	Abbreviations	14
4	Assembly instructions.....	15
5	Post installation checks	27
B	Maintenance instructions Mini Triops Pyramid, Art.-No. 4644-1	29
6	Introduction Maintenance.....	30
7	General maintenance information	31
8	Maintenance timetable.....	33
9	Regular maintenance.....	34
10	Monthly maintenance	35
11	Quarterly maintenance	35
12	Half yearly maintenance	36
13	Annual maintenance.....	36
14	Maintenance printout.....	37
15	Hand over document	39

List of Tables

Table 3-1: Delivery contents, in words	8
Table 3-2: Delivery contents, in symbols.....	10

1 Introduction Assembling

1.1 General information

This equipment should be installed, inspected, maintained and operated in accordance with EN1176-7 guidelines.

Before installation work commences, please check that you have all of the equipment and fixation components in the parts list provided (see Tables 3-1 and 3-2).

Please consider that the installation has to be carried out only on even terrain (max.slope up to 3%).

Any spare parts that may be required can be obtained directly from your supplier or from Fa. Huck Seiltechnik GmbH

Adress: Huck Seiltechnik GmbH
Dillerberg 3
D-35614 Asslar/Berghausen
Tel. +49 6443 83 11-0
Fax +49 6443 83 11-79

Please do not hesitate to call your supplier if you have any problems during installation or with any other questions. You can reach us at the following **Tel. +49 6443 83 11-0.**



Following installation, complete assembly instructions, maintenance instructions and a maintenance record must be sent to the operator who must confirm receipt in writing. See the last page of this document.



All nuts and bolts are hot-dip galvanised or stainless steel. One of the characteristics of stainless steel is that uncontrolled cold welding may occur when the nuts are tightened. To prevent this, it is necessary to spray the nuts and bolts with Teflon spray or another similar lubricant.

Drawings / Views

All optical drawings are showing only the measurements/dimensions and are no mandatory technical views of the complete item.

We reserve the right to change technical details of our articles which are serving for the further development of our articles and are reasonable for the customer.

Measurement tolerances

Because of the properties and characteristics of the components, minor measurement tolerances compared to the indication on the sketches are possible.

This concerns all shown measurements except the foundation measurements resp. measurements below upper edge ground level/play area.

2 Datasheet: “Laola” bird’s nest tree / Art.-No. 4652-60

1. Component zone: 7.25 m x 7.125 m
 safety zone:: 9.50 m x 7.95 m
 Height of equipment: 6.00 m
 Height of Fall: 2.50 m
 Fall protection area: 48,2m²

2. Required safety surface:

Surface material	Description / mm	Minimum thickness of layer / mm	Maximum height of fall / mm
Lawn / topsoil	-	-	≤ 1000*
Bark mulch	20 – 80 Particle size	300	≤ 2000
		400	≤ 3000
Wood chips	5 – 30 Particle size	300	≤ 2000
		400	≤ 3000
Sand	0,25 – 2 Grain size	300	≤ 2000
		400	≤ 3000
Gravel	0,25 – 8 Grain size	300	≤ 2000
		400	≤ 3000
Other floor materials	As per HIC audited		Critical drop height as tested
Sand and gravel must be well rounded to remove most of the silty or clayey particles. Washed sand or gravel is considered to be alluvial and free from silty or clayey particles. With gravel this is generally described as "pearl gravel". Degree of non-uniformity D60/D10 < 3.0. The grain size can be determined by using a sieve method.			

3. Name and size of the largest part of the device:
 Steel post Pos. 01 / Ø193.7 – lg. 6200 mm
4. Name and weight of the heaviest part of the equipment:
 Steel post Pos. 01 / ca. 157 kg
5. Intended age group: from 6 years

6. **Attention! Device for setting in concrete:**

Foundation

- Concrete: C25/30
 Concrete requirements: 7.5 m³
 Foundation size: **1x** 1600 x 1200 x 800 mm
4x 1500 x 1000 x 1000 mm
 Concrete upper edge: 400 mm below upper edge (O.K.) of play level

Excavation size:

- 1x** 1600 mm x 1200 mm x 1300 mm (inclusive 100 mm drainage layer)
4x 1500 mm x 1000 mm x 1500 mm (inclusive 100 mm drainage layer)



Round off foundation edges (min.R = 100 mm)! Sizes of foundations are designed for soils class "4-5" (natural ground).

Soil class 4: soft to medium plasticity, interleave bound, with minor portion of stone (portion < 30% with bigger diameter of 63 mm grain size)

Soil class 5: ground with soil class 3 and 4 with big portion of stones (portion > 30% with bigger diameter of 63 mm grain size)

In case of sandy and soft soils, the surface measure of foundations have to be enlarged for about 50%!

7. Assembly time approx.. 2 hours after completion of concreting the steel post
Needed persons: 2

8. Possibly required spare parts can be obtained directly from your supplier or from the company Huck Seiltechnik GmbH

Adress: Huck Seiltechnik GmbH
Dillerberg 3
D-35614 Asslar/Berghausen
Tel. +49(0)6443/8311-99
Fax.+49(0)6443/8311-79

9. **We hereby confirm that this play equipment has been tested and certified in accordance with the play equipment standard EN 1176-1.**

3 Delivery contents (parts list with part numbers)

3.1. In words

Table 3-1: Delivery contents, in words


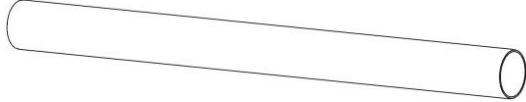
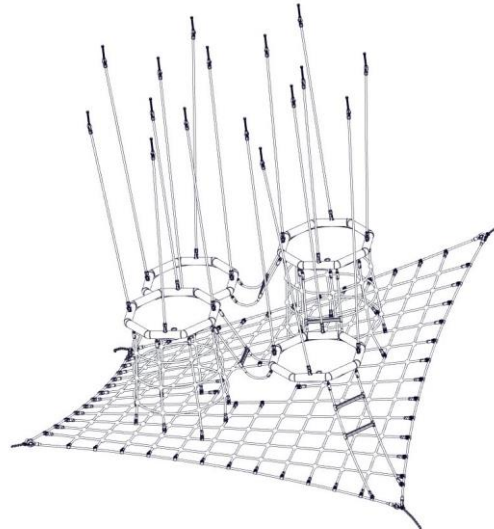
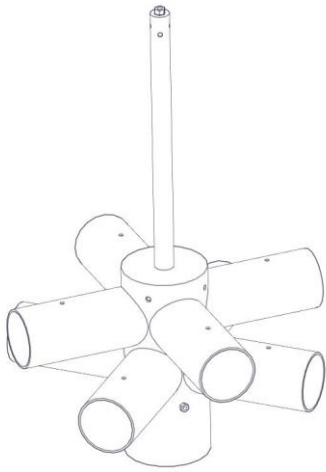
Pos.	Quantity	Element / Description	Size	O.K.	Mis- sing
1	1	Steel pole	Ø 193,7 x 6,3 mm 6,20 m long		
2	4	Steel post	Ø 139 mm x 3,8 m lg.		
3	1	Play part (nets & bird nests)			
4	1	Mast cover			
6	8	Steel arms / black	Ø 139,7 x 4,0 mm, 1,64 m lg.		
7	4	Ropes pre-assembled on top for steel arms (enclosed to the network).			
8	1	Flag / black (incl. threaded rod and 2 x M16 nuts).			
9	20	Hexagon socket screws with flange	M6 x 25 mm VA		
9a	20	Sleeve nut	M6 x 25 mm		
11	16	Stop nut M12 + washer small + black cap	M12 VA Ø 13 VA		
12	8	Eyebolt M12 x 155 mm (8x pre-assembled on steel arms)	M12 VA		
13	12	Cover caps Leon Green	für Ø 140 mm		
14	24	Self-tapping screws	5,5 x 25 mm		
15	8	Threaded rod	M10 x 175 mm verz.		
16	16	Small washers	Ø 11 mm		
17	16	Cap nut	M10 verz		
18	2	Loctite screw lock	je 3 ml		
19	8	Hexagon socket set screw ISO 4027(for mast hood)	M12 x 25 mm VA		
20	8	chain mount (8 piece preassembled)			
21	4	Perforated discs (preassembled)	Ø 60 mm VA		


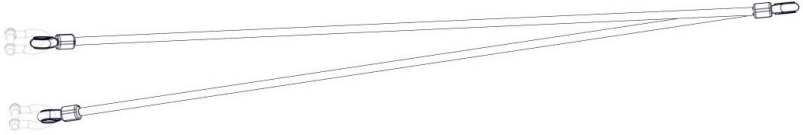
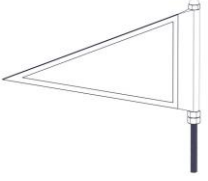

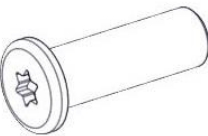
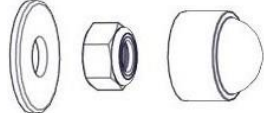




Table 3-1: Delivery contents, in words










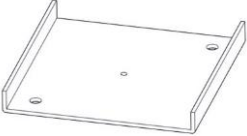
Pos.	Quantity	Element / Description	Size	O.K.	Mis-sing
22	4	Slotted washers	Ø 60 mm VA		
23	8	Self-tapping screws	5,5 x 25 mm		
24	4	Self-tapping screws	6,3 x 45 mm		
25	1	Anchor plate with ring nut M16 + screw M16 x 30 mm (middle foundation)	500 x 500 mm		
26	4	Anchor plate with tube	500 x 500 mm		
27	10	Ground nails (2 per anchor plate)	ca. 400 mm		
28	2	6 shackle (as spare)			
29	1	Chain tensioner (crowbar)			
30	8	Reinforcing bar (to be provided by the customer)	U-Form 600 x 1000 Ø10		
31	1	pipe (to be provided by the customer)	Ø400 x 850 mm long		

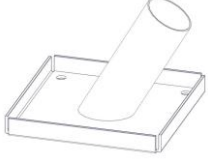

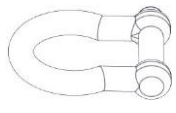


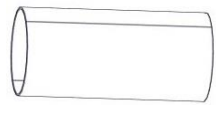
3.2. In symbols

Table 3-2: Delivery contents, in symbols

Pos.	Quantity	Symbol
1	1	 <p>Ø 193,7 x 6,3 mm 6,20 m long</p>
2	4	 <p>Ø 139 mm x 3,8 m lg.</p>
3	1	 <p>Play part (nets & bird nests)</p>
4	1	 <p>Mast cap</p>

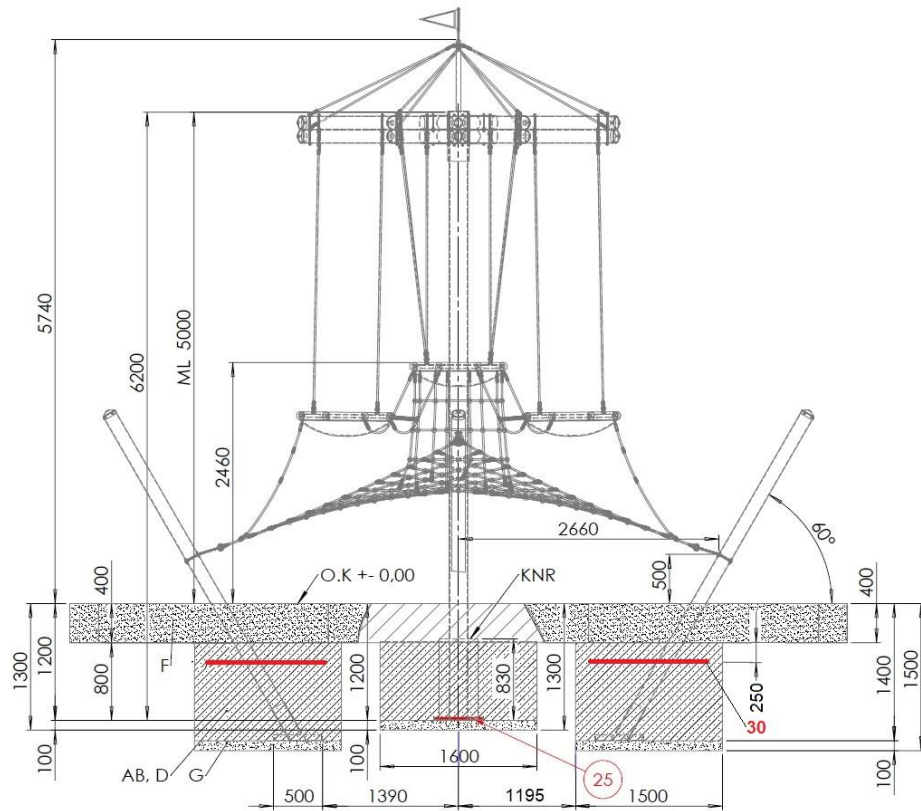
6	8	 <p>Ø 139,7 x 4,0 mm, 1,64 m lg.</p>
7	4	 <p>(preassembled)</p>
8	1	
9	20	 <p>M6 x 35 mm</p>
9a	20	 <p>Hülse 6 x 25 mm</p>
11	16	 <p>M12</p>
12	8	 <p>M12 x 155 (preassembled)</p>
13	8	 <p>for Ø140 mm</p>
14	24	 <p>5,5 x 25 mm</p>
15	8	 <p>M10 x 175 mm</p>

16	16	 Ø11mm
17	16	 M10
18	2	 Loctite 3ml
19	8	 M12 x 25 mm
20	8	 chain mount (8 piece preassembled)
21	4	 preassembled
22	4	
23	8	 5,5 x 25 mm
24	4	 6,3 x 45 mm
25	1	 500 x 500 mm

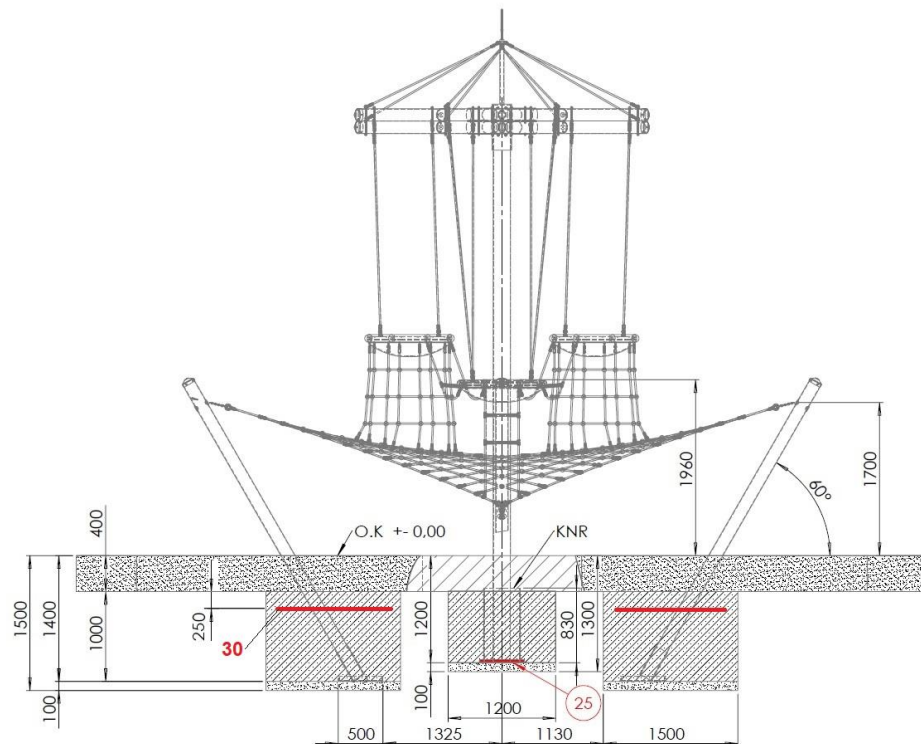
26	4	
27	10	 300 mm long
28	2	 (as spare)
29	1	 Chain tensioner
30	8	 Reinforcing bar (to be provided by the customer)
31	1	 pipe (to be provided by the customer)

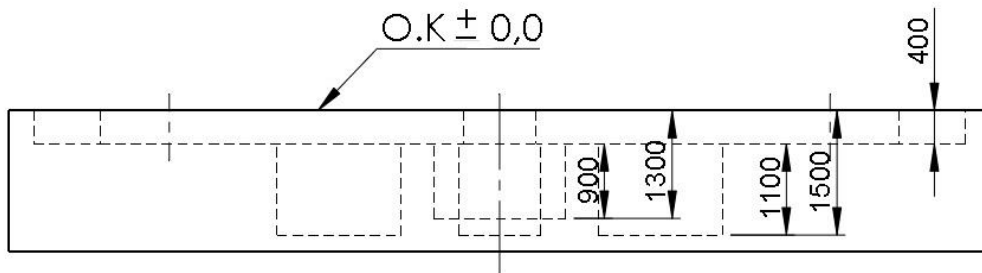
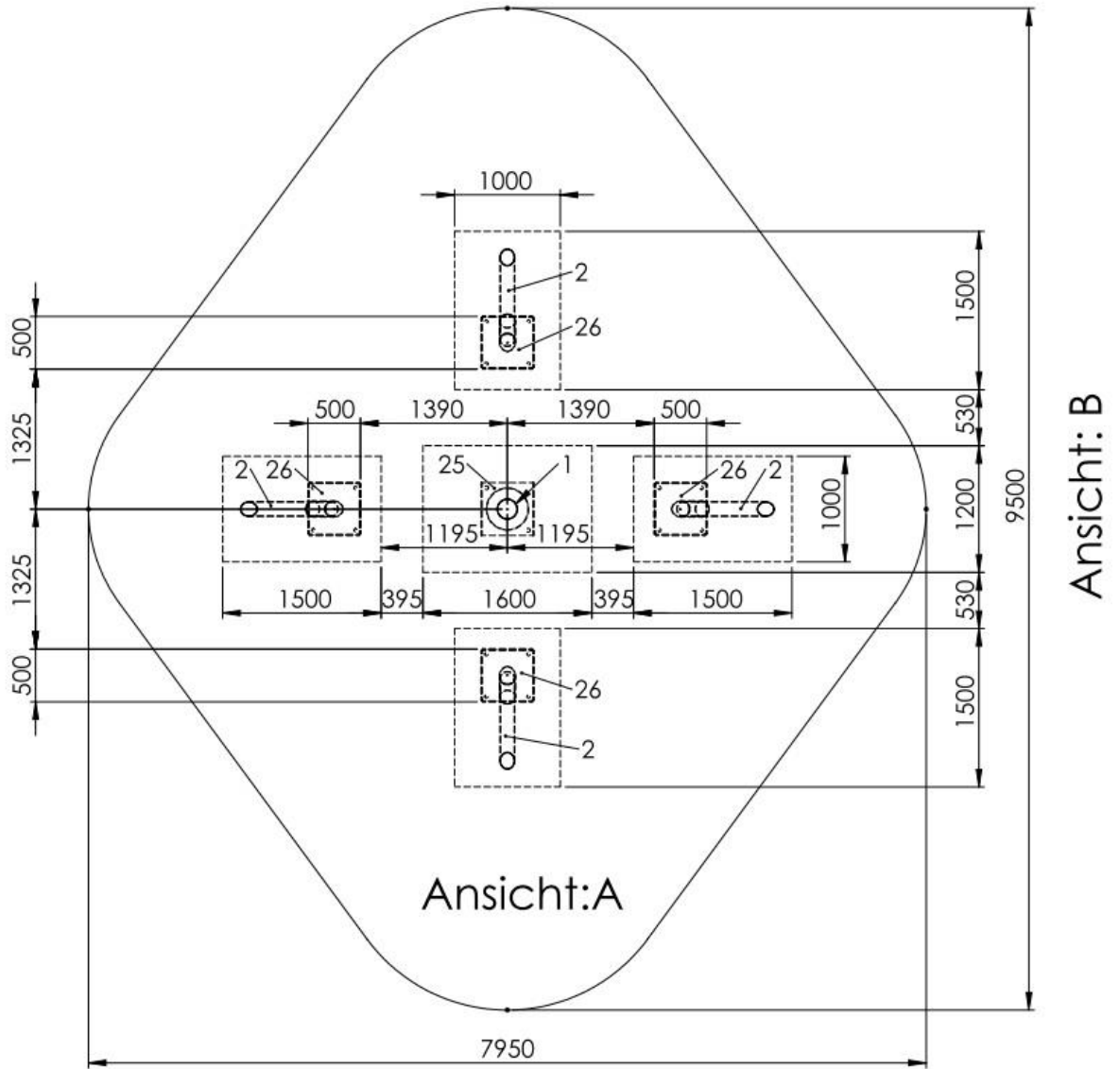
Abbreviations	
AB	The legally prescribed setting times must be observed!
D	C25/30 concrete (for foundations) Q.ty required: 0,052 m ²
DT	Detail
EDF	Screw the ground anchor into the foundation
ER	Ground, fall protection etc. (ground) 100 mm thick
F	Fall protection
FOU	Foundation
G	Drainage layer
Lg.	length
LRB	Fill the empty pipe with liquid concrete after installation!
OAZ	The opening must point outwards / not in the direction of pull
O.K	Top edge play level
O.K.F.	Top edge foundation
PS	Minimum safety area
PSA	Adjust the pipe clamps so that the bird's nest, upper edge ring, is 1000 mm above the play level (O.K.)
UEA!	Repair any unevenness / hollows that occur when the soil anchor is screwed in. Otherwise a water accumulation will form

4 Assembly instructions

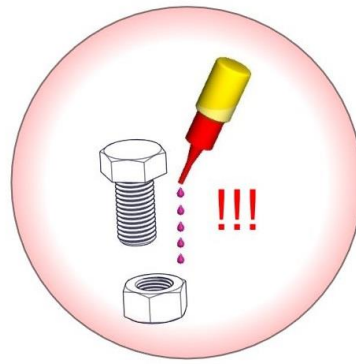


Side view: pay attention to both sides important!

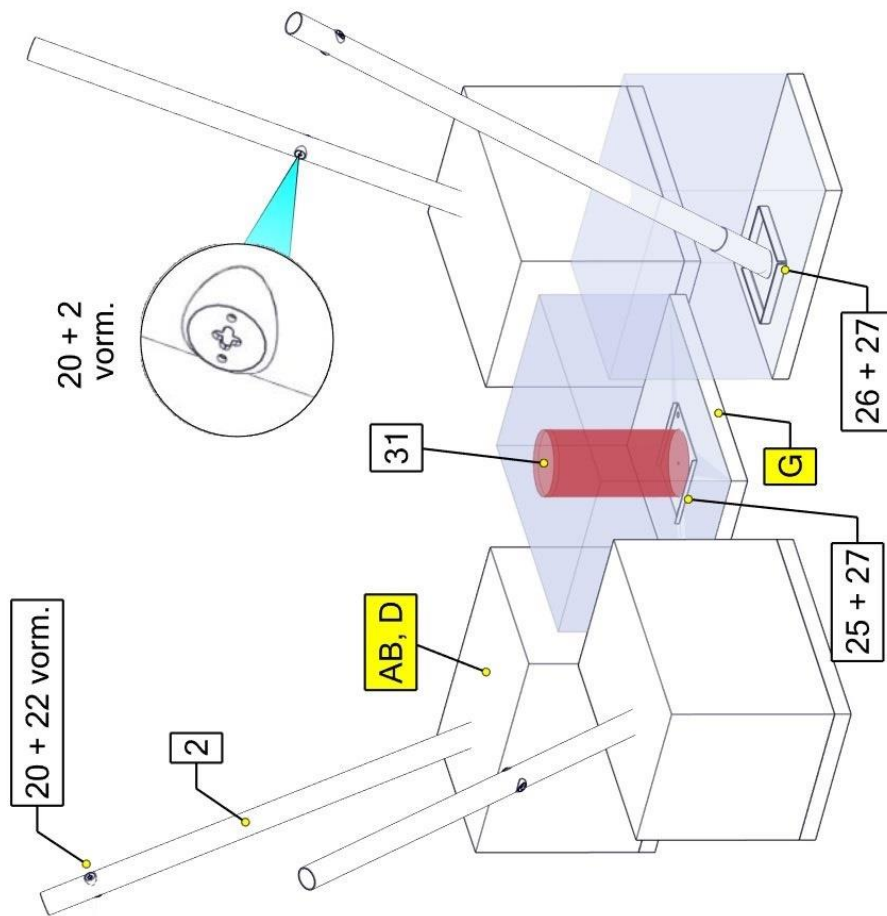


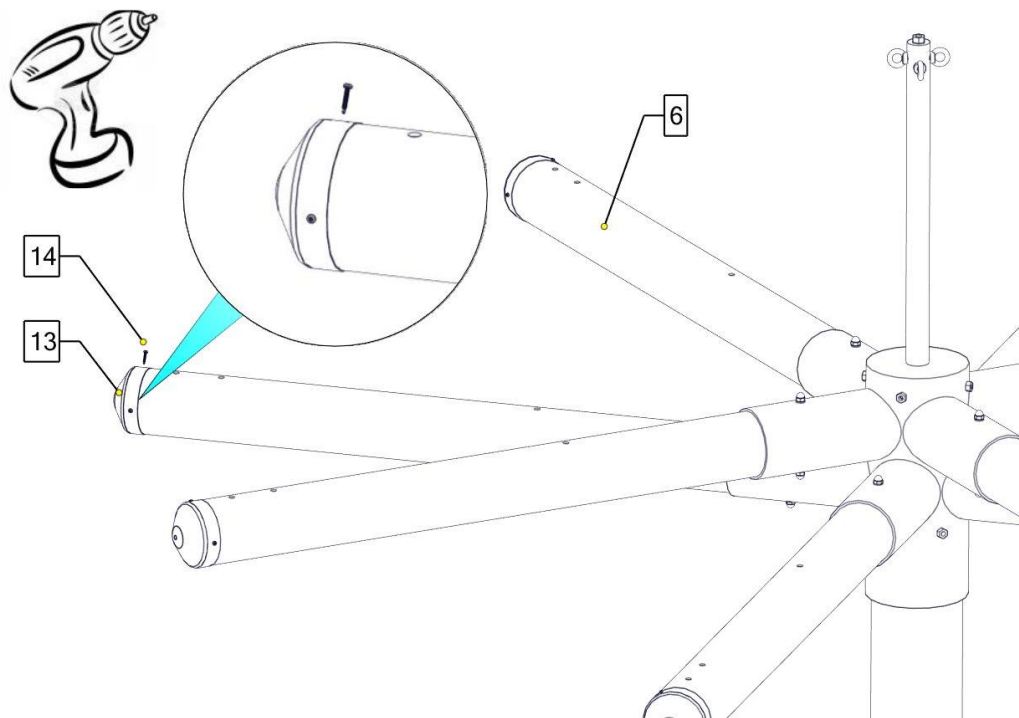
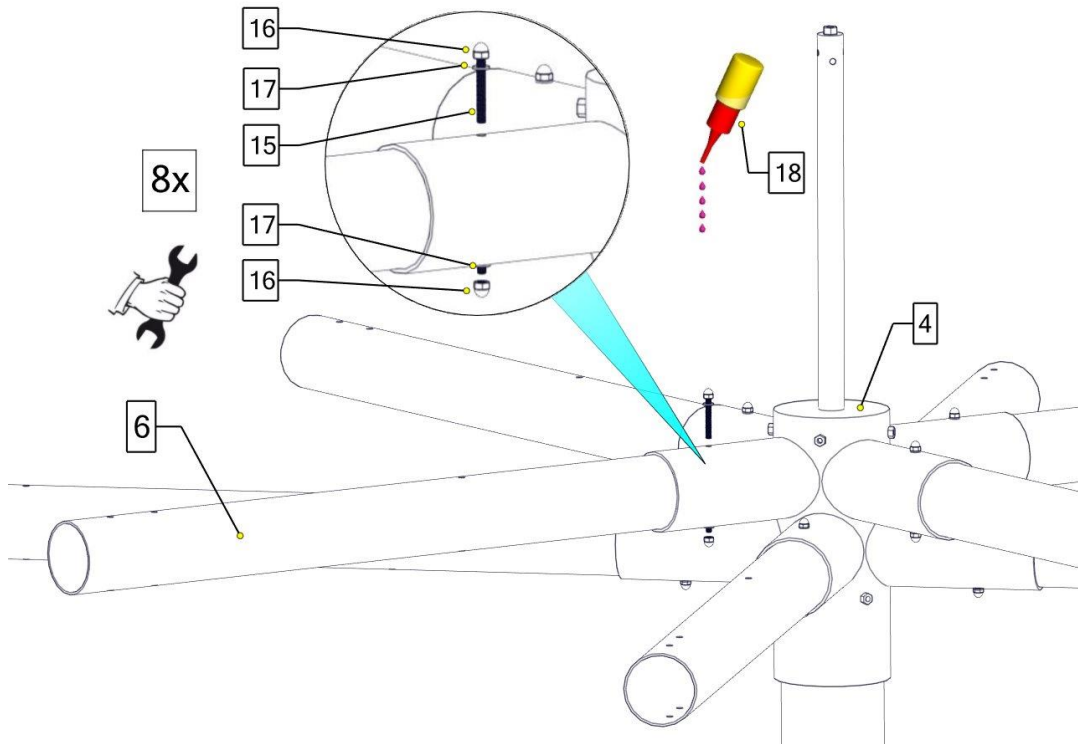


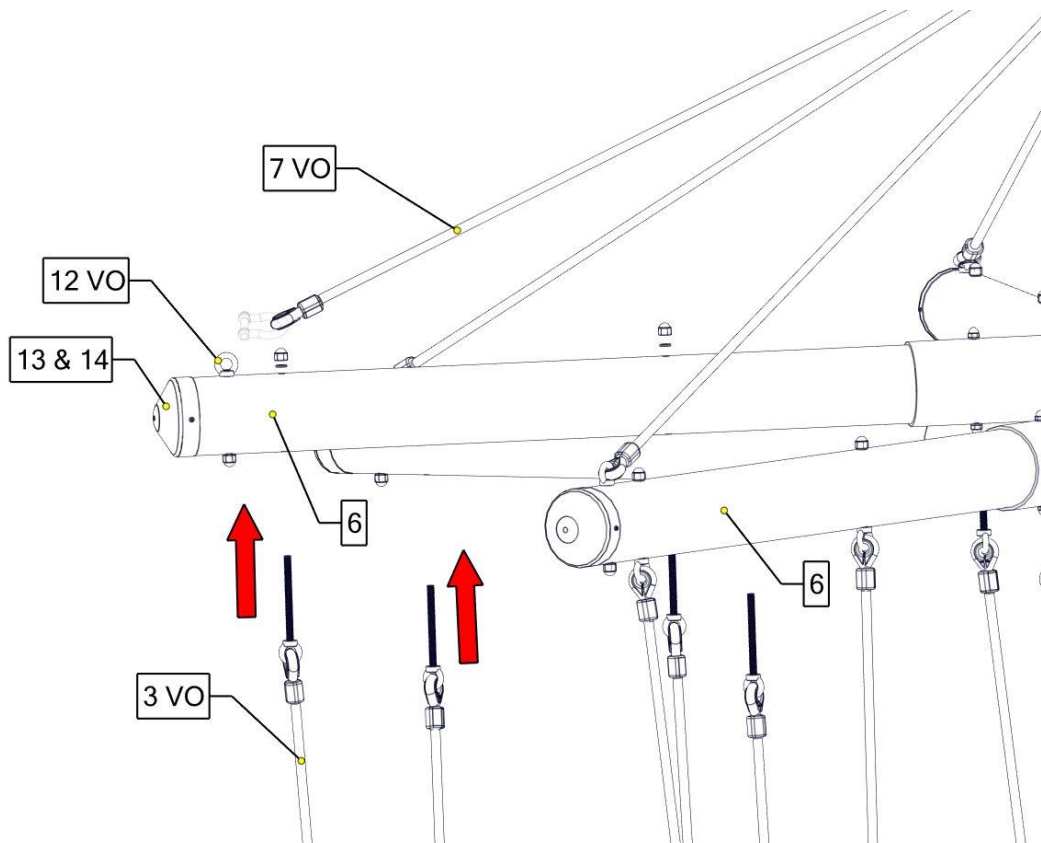
Screw locking device!



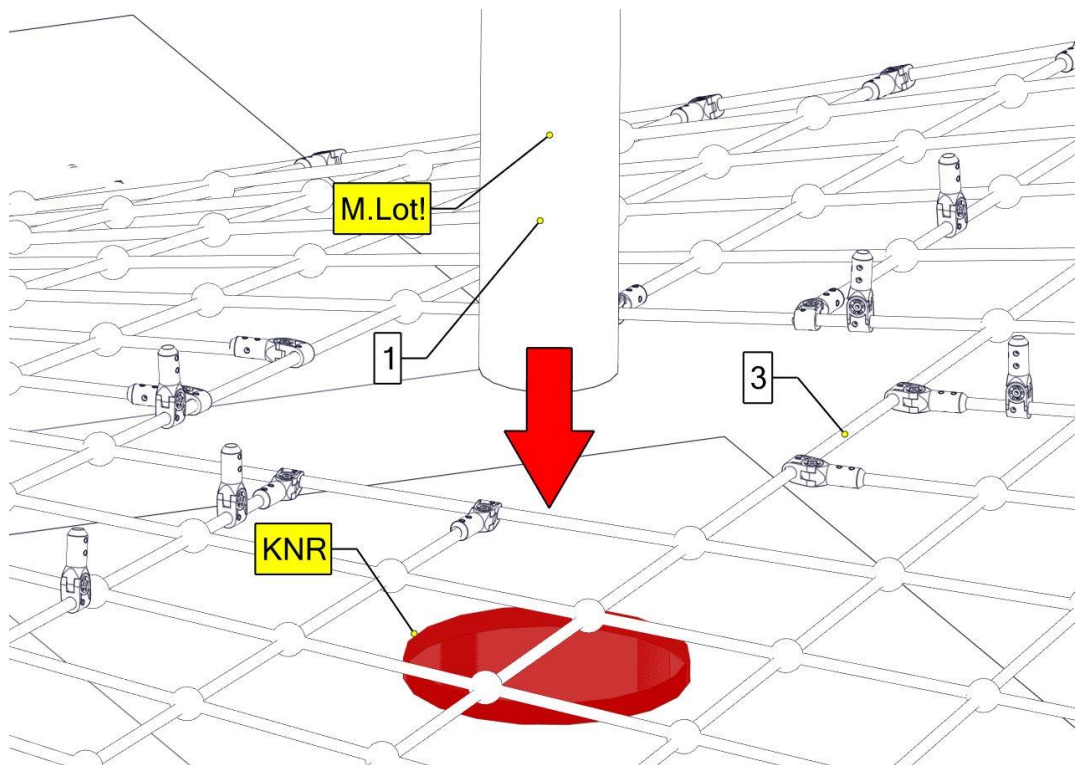
**Glue all screw´s, nuts and sleeves with loctite.
(not les than 5 drops!)
(except for lock nut)**

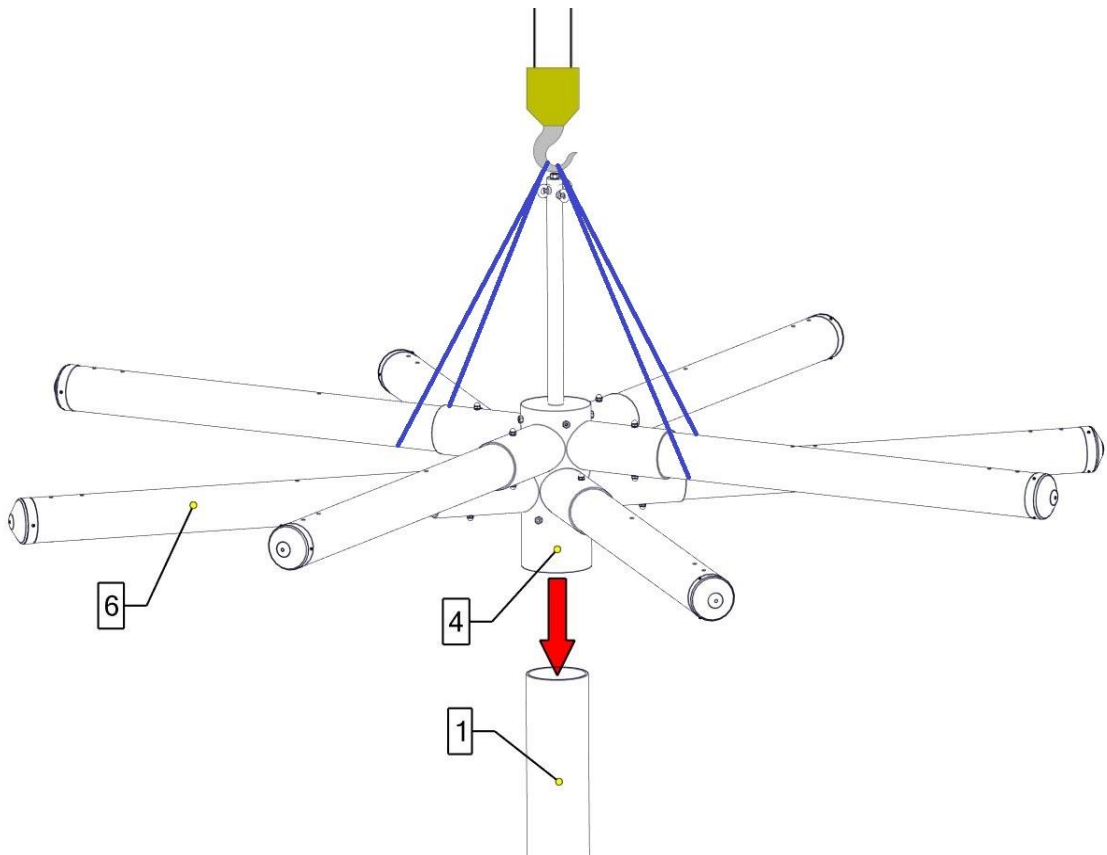
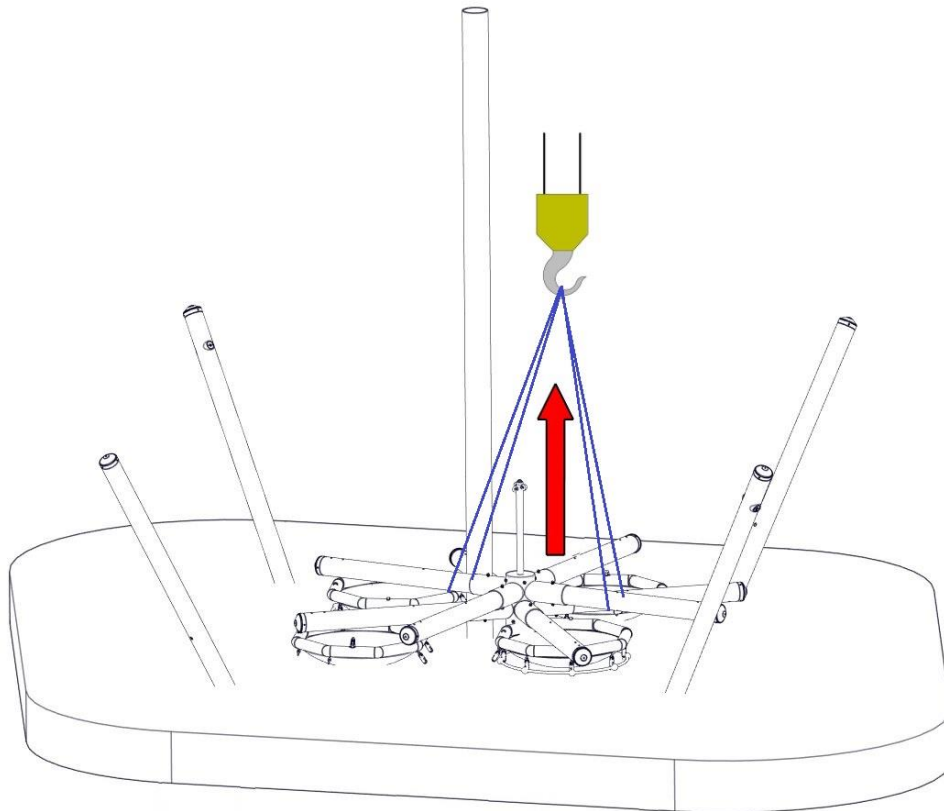




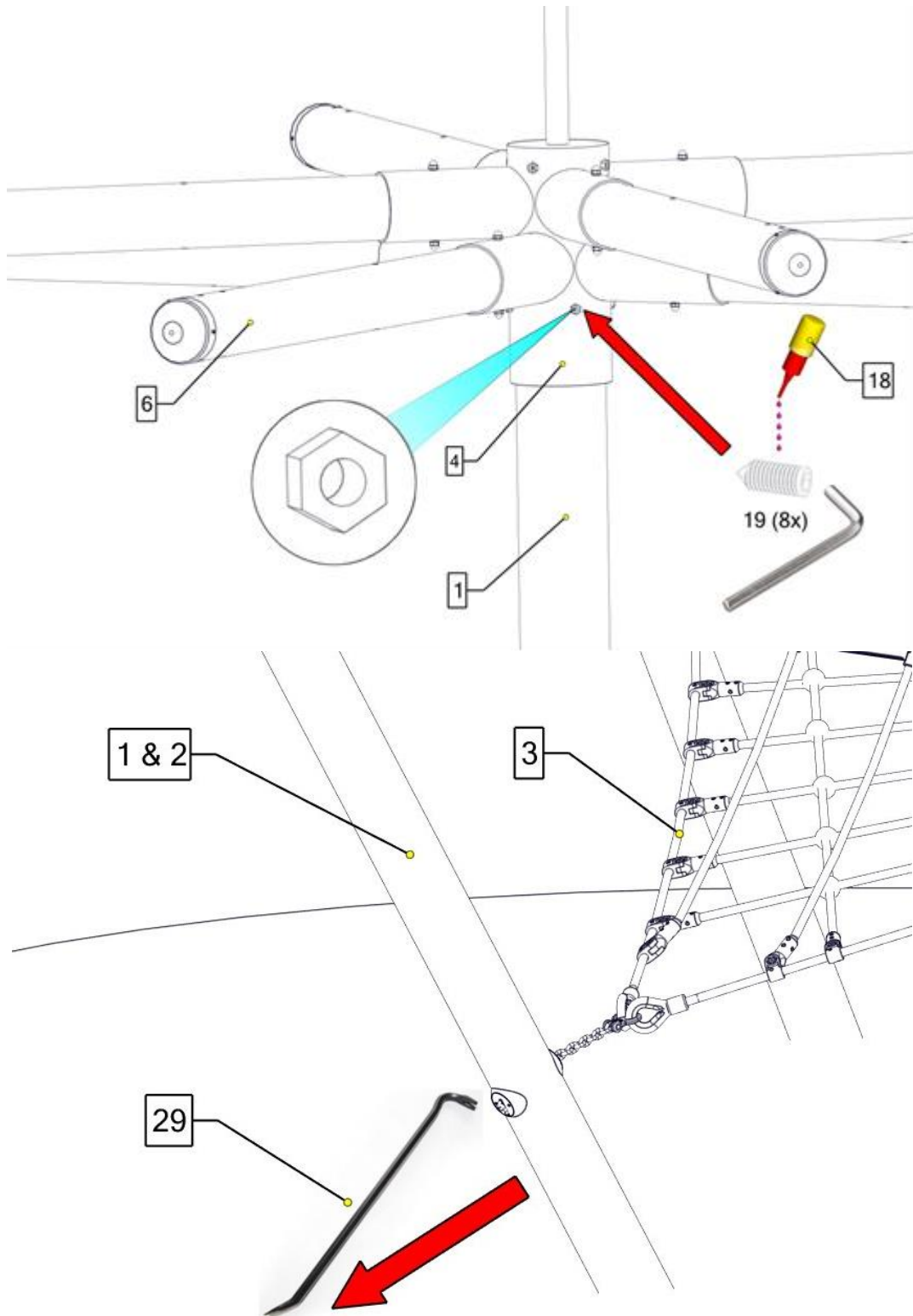


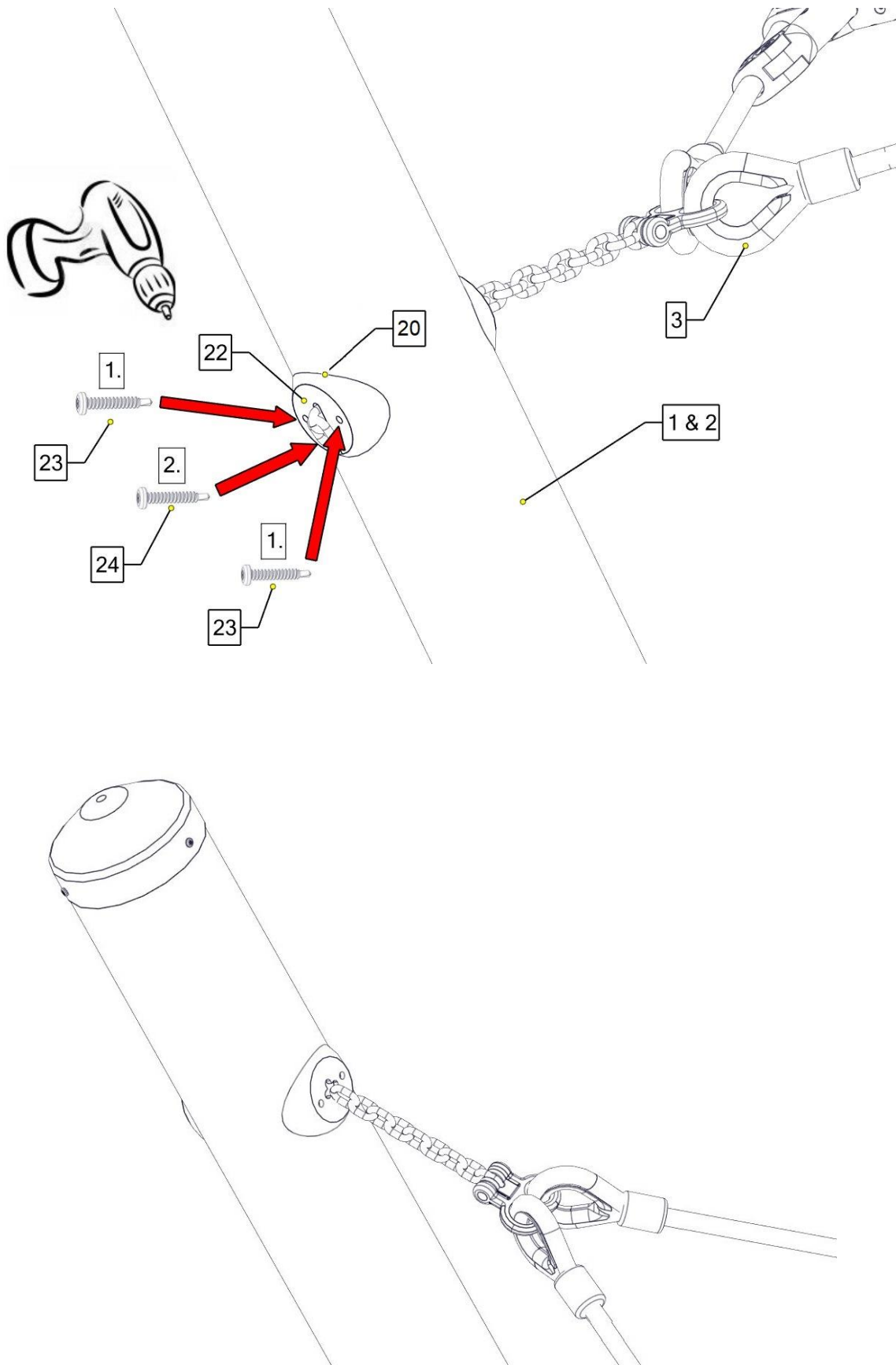
Mount to the floor!



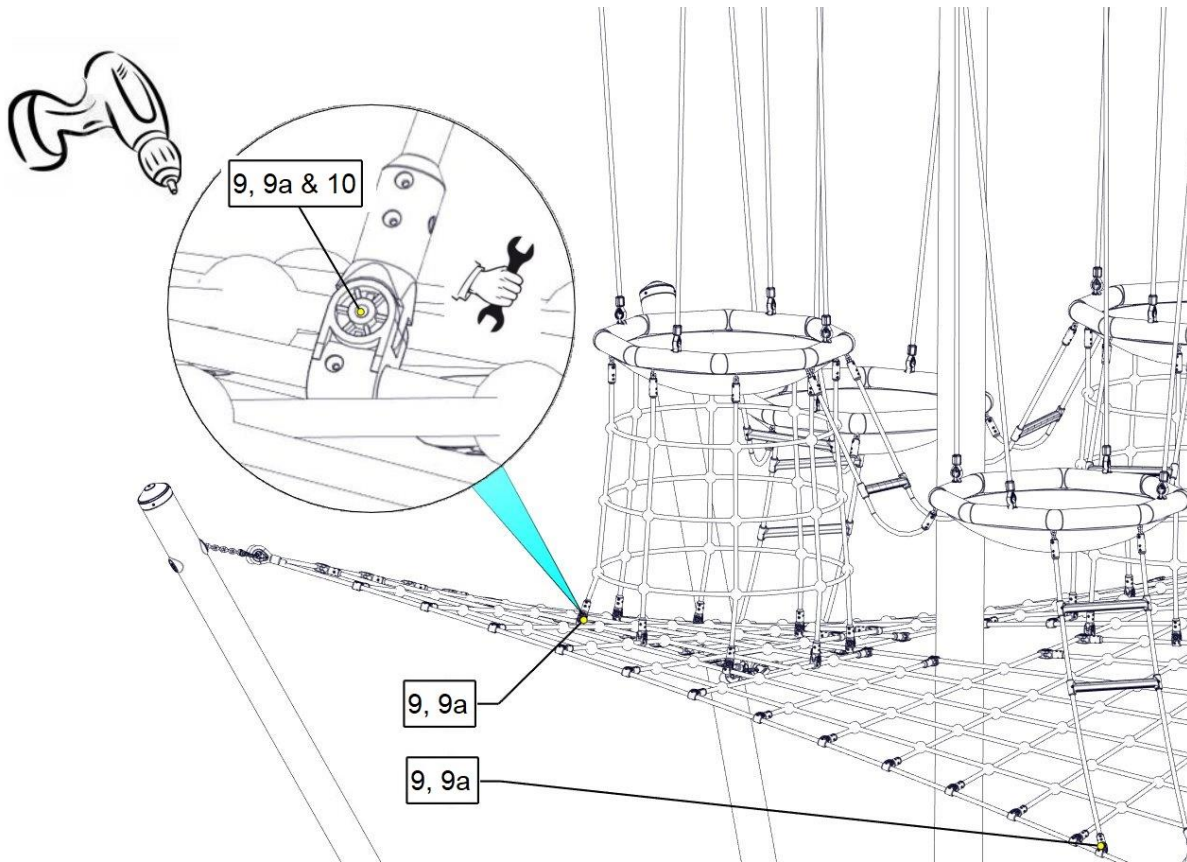
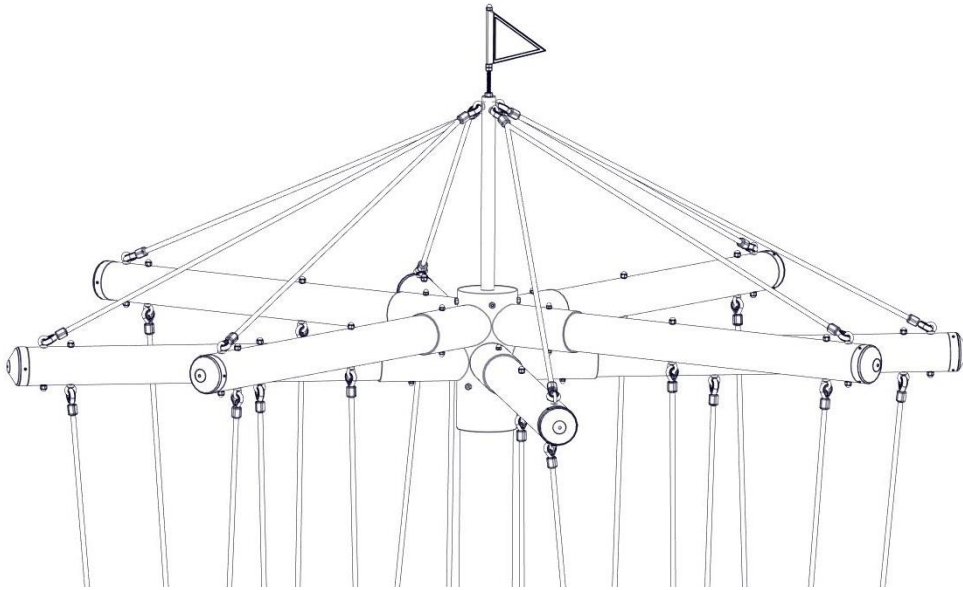


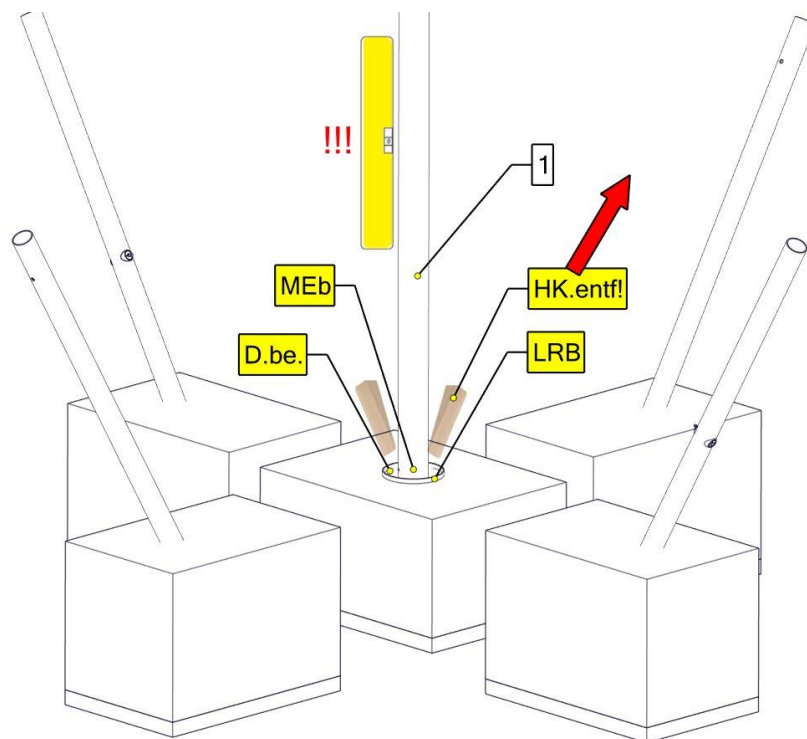
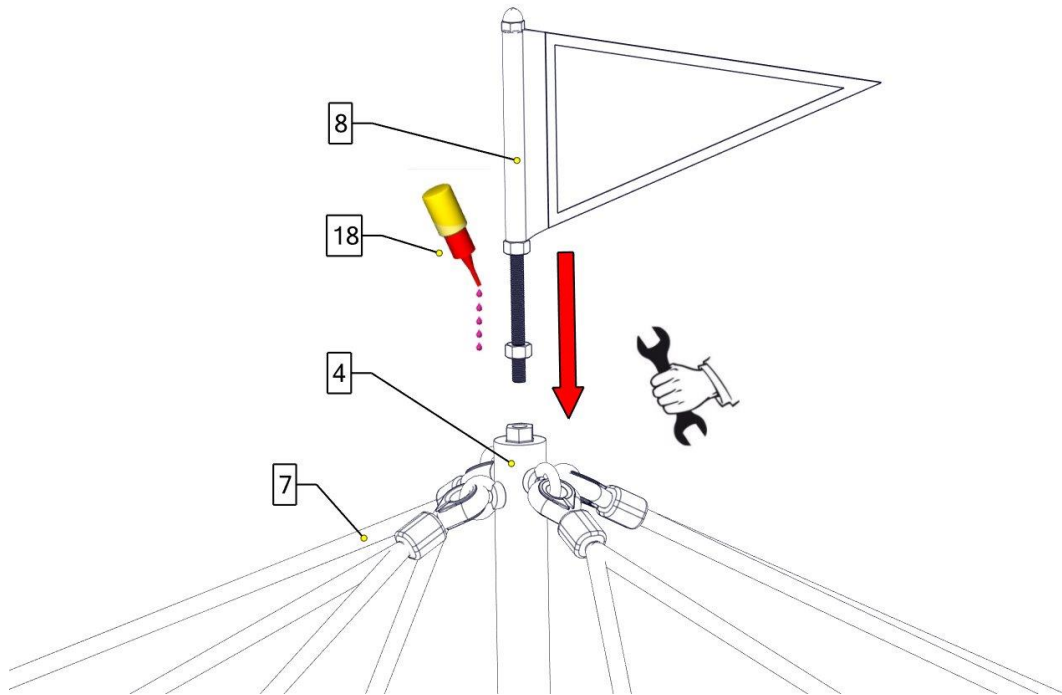
without play parts (pos. 3 + pos. 5)

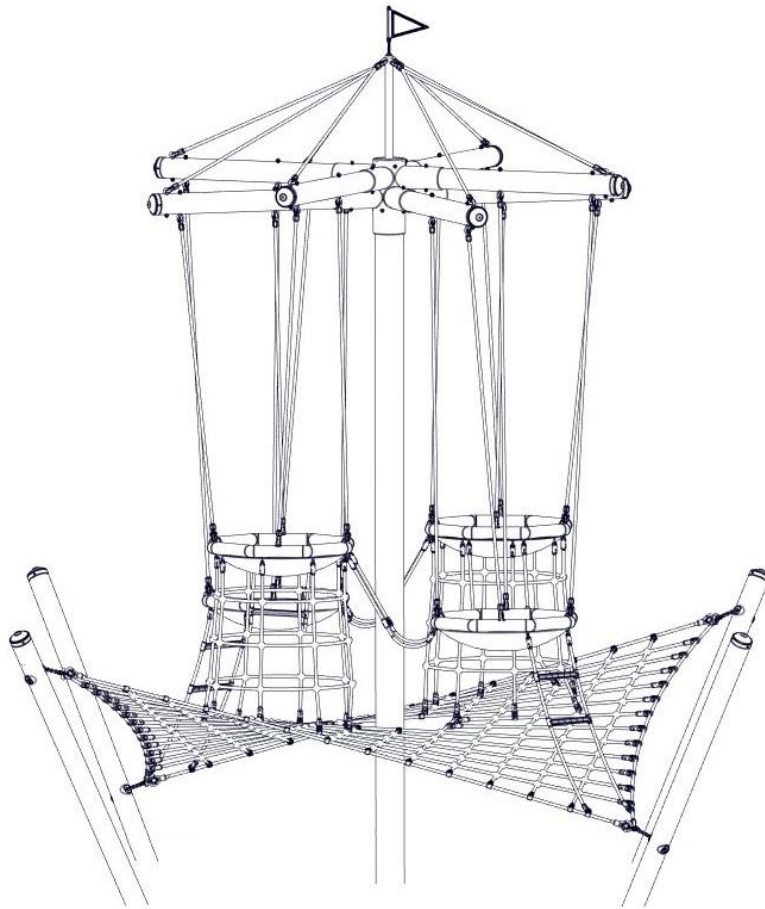




Pretension evenly - equal number of links at all connection points.







5 Post installation checks



Notice

If the equipment has not been installed safely, you must ensure that the public is prevented from using it.

5.1 Marking filler depth

Labelling the posts to show the depth of material provided as fall protection (i.e. loose filler).

5.2 The equipment has not been installed safely in the following cases:

- Safe equipment installation is not complete.
- The protective surface has not been installed yet.
- Appropriate maintenance work cannot guarantee operational safety.

5.3 Removal of all assembly aids

Please make sure that all assembly aids have been removed from the playing area. The equipment must not be approved for use until this check has been made.

5.4 Information about inspection of the equipment before it is used for the first time

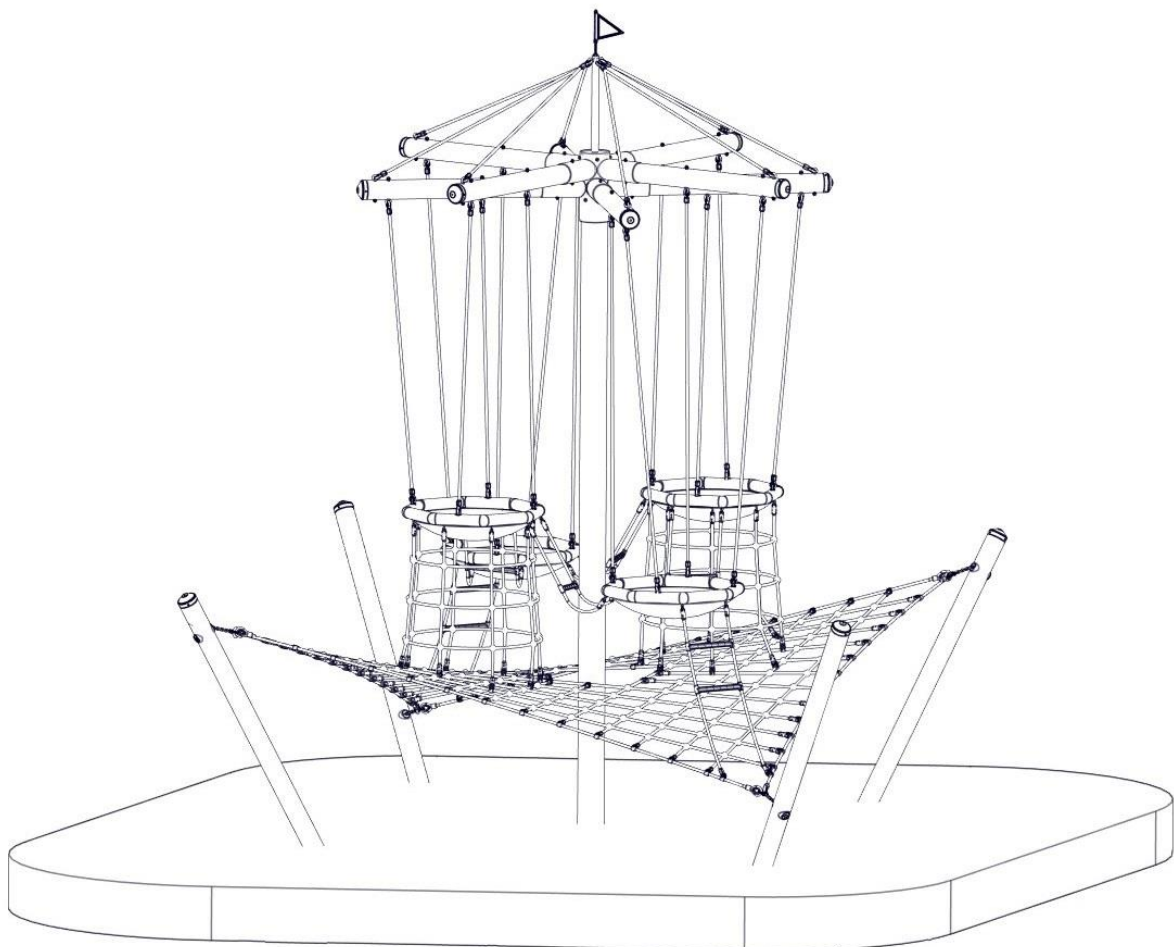
There are no special inspection requirements to be met before the equipment is used for the first time.

5.5 Retighten bolts

After one week of play, please retighten all bolts again. Later upon respective maintenance.

.

B Maintenance instructions **“Laola” bird’s nest tree, Art.-No. 4652-60**



6 Introduction Maintenance

6.1 General informations

This equipment should be installed, inspected, maintained and operated in accordance with EN 1176-7 guidelines.



Notice

Please note: Providing any necessary repairs are carried out, a piece of play equipment that is inspected regularly cannot become so damaged that it is dangerous.

Any spare parts which may be required can be obtained directly from your supplier or from Fa. Huck Seiltechnik GmbH

Adress: Huck Seiltechnik GmbH
Dillerberg 3
D-35614 Asslar/Berghausen
Tel. +49 6443 83 11-99
Fax +49 6443 83 11-79



This equipment should only be assembled, maintained and repaired by **persons with the necessary expertise.**

A copy of the inspection record should be given to the operator, who must confirm receipt.

**This maintenance instruction is based on the standard
“EN 1176-1:2017”.**

7 General maintenance information

7.1 Maintenance intervals

Maintenance intervals are based on average use. Please note that more frequent inspections and/or maintenance are required if the play equipment is subject to intensive use.

7.2 Inspection frequency

The frequency of inspections must be based on actual use. Factors that affect frequency include vandalism, location (e.g. coastal proximity), air pollution and the age of the equipment.

7.3 Maintenance products and procedures

All nuts and bolts are hot-dip galvanised or stainless steel. One of the characteristics of stainless steel is that uncontrolled cold welding may occur when the nuts are tightened. To prevent this, it is necessary to spray the nuts and bolts with Teflon spray or another similar lubricant.

7.4 Spare parts

All spare parts must conform to the manufacturer's specifications.

7.5 Identifying spare parts

All spare parts are listed in the parts list. The parts list follows the installation requirements.

7.6 Special instructions for the disposal of individual equipment components

No special instructions are necessary for the disposal of individual equipment components.

7.7 Special measures during the break-in period

No later than 2 weeks after assembly, all screwed connections should be checked and tightened if necessary.

7.8 Maintenance of protective surfaces

Surfaces providing fall protection must also be maintained regularly. It is particularly important to maintain the correct level of loose surface material and add more if necessary.

7.9 Faults



Faults must be repaired as soon as they are detected. If serious defects that compromise safety cannot be repaired straight away, the public must be prevented from using the equipment with immediate effect.

7.10 Loose screws



Loose screws always cause quality problems and put safety at risk. Therefore, loose screws should always be tightened and checks carried out to ensure that there are no missing screws (e.g. look out for holes you can see through).

7.11 Preventing equipment use

Use of the equipment should be prevented in the event of incomplete installation, disassembly, maintenance, repairs and faults.

7.12 Claims/liability for faults

Steel posts and footings are guaranteed if regular maintenance is carried out and recorded in writing. Our general terms and conditions apply. Maintenance first takes place after 3 years. The steel posts must be excavated as far as the concrete foundations and checked for corrosion.

Zinc paint should be applied to any corroded areas and scratches. Check ropes for abrasion. Retreat any that are very worn.

8 Maintenance timetable

8.1 Special advices

8.1.1 Maintenance interval

We strongly advise you to carry out inspections and maintenance work within the specified periods as use of the equipment, the weather and malicious vandalism cause wear and tear that compromises the safety and function of the equipment.

8.1.2 Maintenance intervals in the event of intensive use

Please note that more frequent inspections and/or maintenance are required if the play equipment is subject to intensive use.

8.1.3 Faults that compromise safety



Notice

In the event of a fault that compromises safety, quick action must be taken. This may involve repairing it immediately or shutting down and dismantling the equipment.

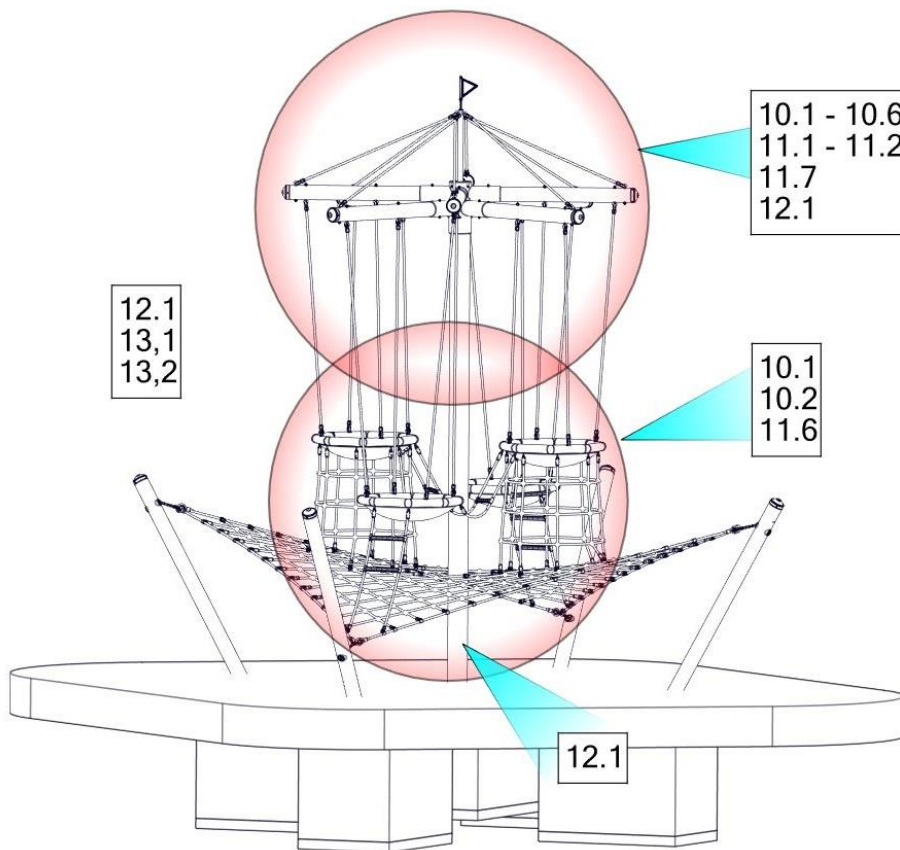
8.1.4 Faults that compromise function



Notice

Faults that compromise function should also be repaired immediately. Such faults lower the value of the equipment to the user and encourage malicious vandalism, which may render the equipment less safe. Any damage should also be repaired immediately.

9 Regular maintenance



Regular maintenance

10 Monthly maintenance

- 10.1 Check the spaces between the equipment and the ground (clearance and height of fall).**
- 10.2 Check the ground surface in the area with fall protection for hard objects and loose foundations.**
- 10.3 Check all connecting elements and fittings for wear and tear and tighten if necessary. Replace damaged or missing parts.**
- 10.4 Check that moving metal parts (joints, springs, etc.) move smoothly and are not worn. Replace if necessary. It is not necessary to lubricate joints as we only use maintenance-free metal roller bearings.**
- 10.5 Check all attachments such as chains, ropes, nets, etc. for damage and replace if necessary.**
- 10.6 Check rubber parts, sleeves, etc. for wear and tear or damage and replace if necessary.**
- 10.7 If necessary, remove excess padding material from the post footings due to danger of rotting.**
- 10.8 Check the surface of wooden parts for damage caused by the weather or external influences and mould. Repair or replace if necessary.**
- 10.9 Check the surface of plastic and metal parts, e.g. slides, for damage and replace if necessary.**

11 Quarterly maintenance

- 11.1 Detailed inspection of the operation and stability of the equipment paying particular attention to any wear and tear.**
- 11.2 Tighten all forms of attachment.**
- 11.3 Repaint and retreat surfaces.**
- 11.4 Maintenance of fall protection surfaces.**
- 11.5 Lubrication of joints.**
- 11.6 Check the height of the fall and top up with loose filler if necessary. If the posts are labelled, top up as far as the mark.**
- 11.7 Retighten all bolts**

12 Half yearly maintenance

- 12.1 **Stability (check posts, bracing, foundations, etc.). Ascertaining whether there are any changes in equipment safety as a result of repairs that have been carried out or components that have been added or replaced.**

 Attention	<h1>Annual Maintenance</h1>
---	-----------------------------

13 Annual maintenance

- 13.1 **Ascertaining that the equipment, foundations and surfaces are safe for operation.**
- 13.2 **In particular, the equipment should be checked for decay and corrosion. It may be necessary to dig out or excavate certain components in order to do so. Zinc paint should be applied to corroded areas and scratches.**



The equipment must be inspected by someone **with the necessary expertise** in strict compliance with the instructions issued by Huck Seiltechnik GmbH.

A copy of the inspection record should be given to the operator, who must confirm receipt.

15 Hand over document



After the installation of the equipment pass the installation and maintenance documents to the operator. The operator has to receive the hand over documents. The complete filled and signed hand over document should be sent to the supplier Huck Seiltechnik GmbH per Telefax +49 6443 8311-79

Art.-No.: 4652-60

Type of item: "Laola" bird's nest tree

Serial number: _____

Customer or operator (Town, Town council, Kindergarten, etc.):

Competent person in charge:

Installation company (address):

Responsible assistant (assembler):

Received the complete assembly instructions, maintenance instructions and maintenance printout,

(Signature of operator)
(Stamp)

(Signature of installation company)

Date: _____