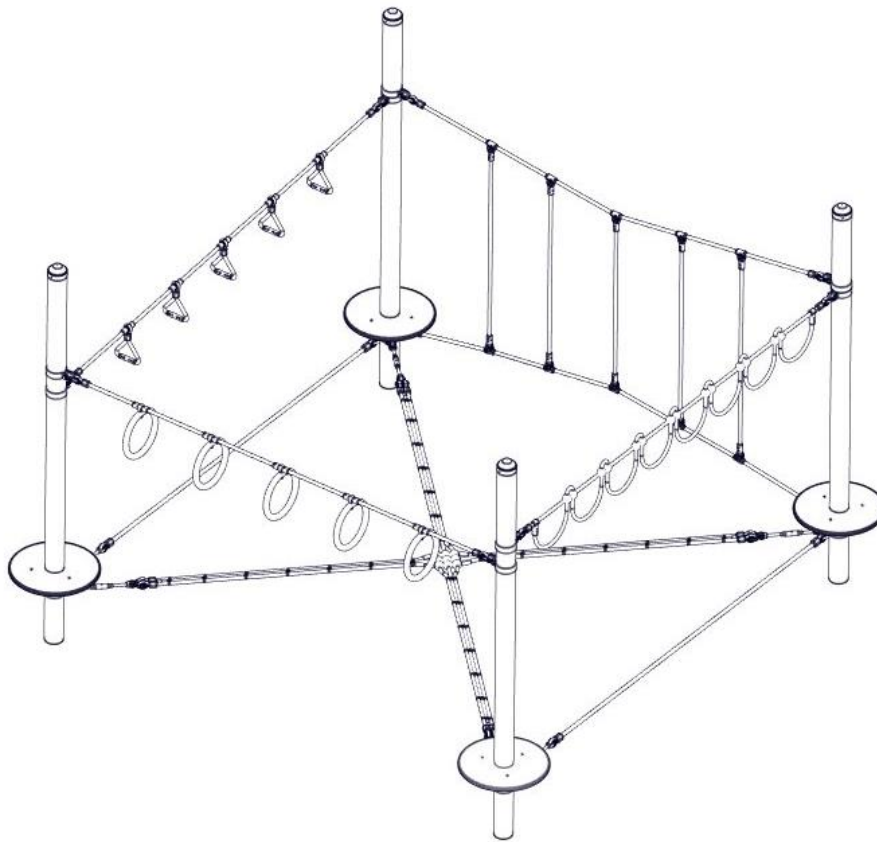


A Assembly Instructions
Slack Master Combination 2
Art. 4591-72



Operator: _____

Location: _____

Revision history

Revision 0 – 2012-20-06

The first allowed version

Revision 04 2023-03-21 PR

neue form der Anleitung
All rights reserved

© Copyright 2013 Huck Seiltechnik GmbH

Contents

A	Assembly Instructions Slack Master Combination 2 Art. 4591-72	1
1	Introduction Assembling	4
2	Datasheet, Slack Master Combination 2 Art. 4591-72	5
3	Delivery contents (parts list with part numbers)	7
4	Erection instructions	11
5	Post installation checks	18
B	Maintenance Instructions Slack Master Combination 2 Art.4591-72	17
6	Introduction Maintenance	18
7	General maintenance information.....	19
8	Maintenance timetable	21
9	Regular maintenance.....	22
10	Monthly maintenance	23
11	Quarterly maintenance	23
12	Half yearly maintenance.....	24
13	Annual maintenance.....	24
14	Maintenance printout.....	26
15	Hand over document	28

List of Tables

Table 3-1: Delivery contents, in words	7
Table 3-2: Delivery contents, in symbols.....	8

1 Introduction Assembling

1.1 General information

This equipment should be installed, inspected, maintained and operated in accordance with EN1176-7 guidelines.

Before installation work commences, please check that you have all of the equipment and fixation components in the parts list provided (see Tables 3-1 and 3-2).

Please consider that the installation has to be carried out only on even terrain (max.slope up to 3%).

Any spare parts that may be required can be obtained directly from your supplier or from Fa. Huck Seiltechnik GmbH

Adress: Huck Seiltechnik GmbH
Dillerberg 3
D-35614 Aßlar/Berghausen
Tel. +49 6443 83 11-0
Fax +49 6443 83 11-79

Please do not hesitate to call your supplier if you have any problems during installation or with any other questions. You can reach us at the following **Tel. +49 6443 83 11-0.**



Following installation, complete assembly instructions, maintenance instructions and a maintenance record must be sent to the operator who must confirm receipt in writing. See the last page of this document.



All nuts and bolts are hot-dip galvanised or stainless steel. One of the characteristics of stainless steel is that uncontrolled cold welding may occur when the nuts are tightened. To prevent this, it is necessary to spray the nuts and bolts with Teflon spray or another similar lubricant.

2 Datasheet, Slack Master Combination 2 Art. 4591-72

1. Space requirement: 3,50 x 3,50 m
 Height of equipment: 2,44 m
 safety zone: 6,50 x 6,50 m
 Height of fall: 1,25 m
 Fall protection area: 37,86 m²

2. Required safety surface:

Surface material	Description mm	Minimum thickness of layer mm	Maximum height of fall mm
Lawn / topsoil	-	-	≤ 1000*
Bark mulch	20 – 80 Particle size	300	≤ 2000
		400	≤ 3000
Wood chips	5 – 30 Particle size	300	≤ 2000
		400	≤ 3000
Sand	0,25 – 2 Grain size	300	≤ 2000
		400	≤ 3000
Gravel	0,25 – 8 Grain size	300	≤ 2000
		400	≤ 3000
Other floor materials	As recommended by manufacturer		Critical drop height as tested
<small>Sand and gravel must be well rounded to remove most of the silty or clayey particles. Washed sand or gravel is considered to be alluvial and free from silty or clayey particles. With gravel this is generally described as "pearl gravel". Degree of non-uniformity D60/D10 < 3.0. The grain size can be determined by using a sieve method.</small>			

3. Name and size of the largest part of the device:
Steel posts Pos. 01 length 3400, Ø101,6 mm
4. Name and weight of the heaviest part of the equipment:
Steel posts Pos. 01 – 24,15 kg
5. Intended age group: 3 years and over
6. **Attention! Device for setting in concrete:**

Foundation size: 4x 800 x 800 x 600

Concrete: C25/30
 Required concrete: 1,54 m³

Excavation size: 4x 800 x 800 x 1100 mm (incl. 100 mm drainage layer)

7.



Attention!

Round off foundation edges (min.R = 100 mm)! Sizes of foundations are “4-5” (natural ground).

Soil class 4: soft to medium plasticity, interleave bound, with minor portion of stone (portion < 30% with bigger diameter of 63 mm grain size).

Soil class 5 : ground with soil class 3 and 4 with big portion of stones (portion > 30% with bigger diameter of 63 mm grain size).

In case of sandy and soft soils, the surface measure of foundations have to be enlarged for about 50%!

8. Assembly time, once foundations completed: 3 hours.
Required assistants: 2 persons.

9. Possibly required spare parts can be obtained directly from your supplier or from the company Huck Seiltechnik GmbH

Adress: Huck Seiltechnik GmbH
Dillerberg 3
D-35614 Aßlar/Berghausen
Tel. +49(0)6443/8311-0
Fax.+49(0)6443/8311-79

10. We hereby confirm that this item of play equipment has been tested and certified in accordance with the play equipment standard EN 1176.

3 Delivery contents (parts list with part numbers)



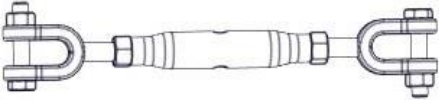

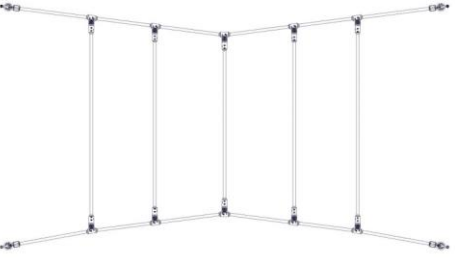

3.1 In words

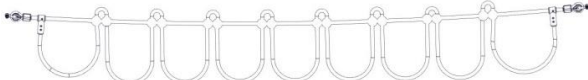


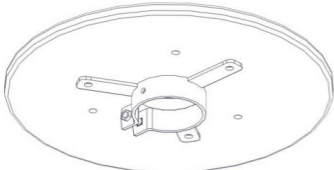


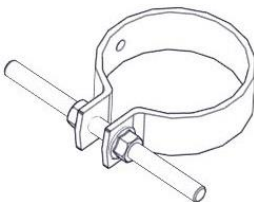
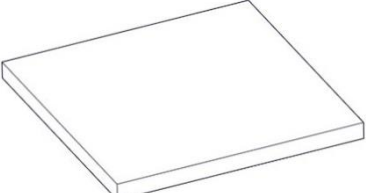
Table 3-1: Delivery contents, in words

Pos.	Quantity	Element / Description	Size	O.K.	Missing
01	4	Steel post	Lg. 3400 mm / Ø 101,6 mm		
02	4	Cover cap red	Ø 101,6 mm		
03	6	Turnbuckle (pre-assembled on Pos. 04 + 09)	M12		
04	1	Slackline	AM 4240 mm		
05	1	Bowline	AM 3000 mm		
06	1	Holding ring	AM 3000 mm		
07	1	Garland Rope	AM 3000 mm		
08	1	Hang loops	AM 3000 mm		
09	2	Balancing rope	AM 3000 mm		
10	4	HDPE plate with pipe clamp	Ø 490 mm		
11	18	Pipe clamp	Ø 101,6 mm		
12	12	Self-drilling screw	4,5 x 25 mm		
13	4	Pipe clamp as ground anchor	Ø 101,6 mm		
14	4	Pavement slab (on site / by customer)	Ca. 300 x 300 mm		

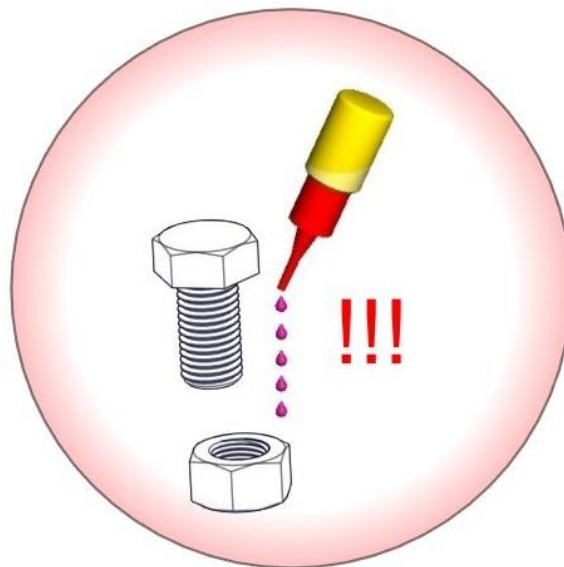
3.2 In symbols

Table 3-2: Delivery contents, in symbols

Pos.	Quantity	Symbol
01	4	 Lg. 3400 mm / Ø 101,6 mm
02	4	 Ø 101,6 mm
03	6	 M12 (pre-assembled on Pos. 04 + 09)
04	1	 AM 4240 mm
05	1	 AM 3000 mm
06	1	 AM 3000 mm

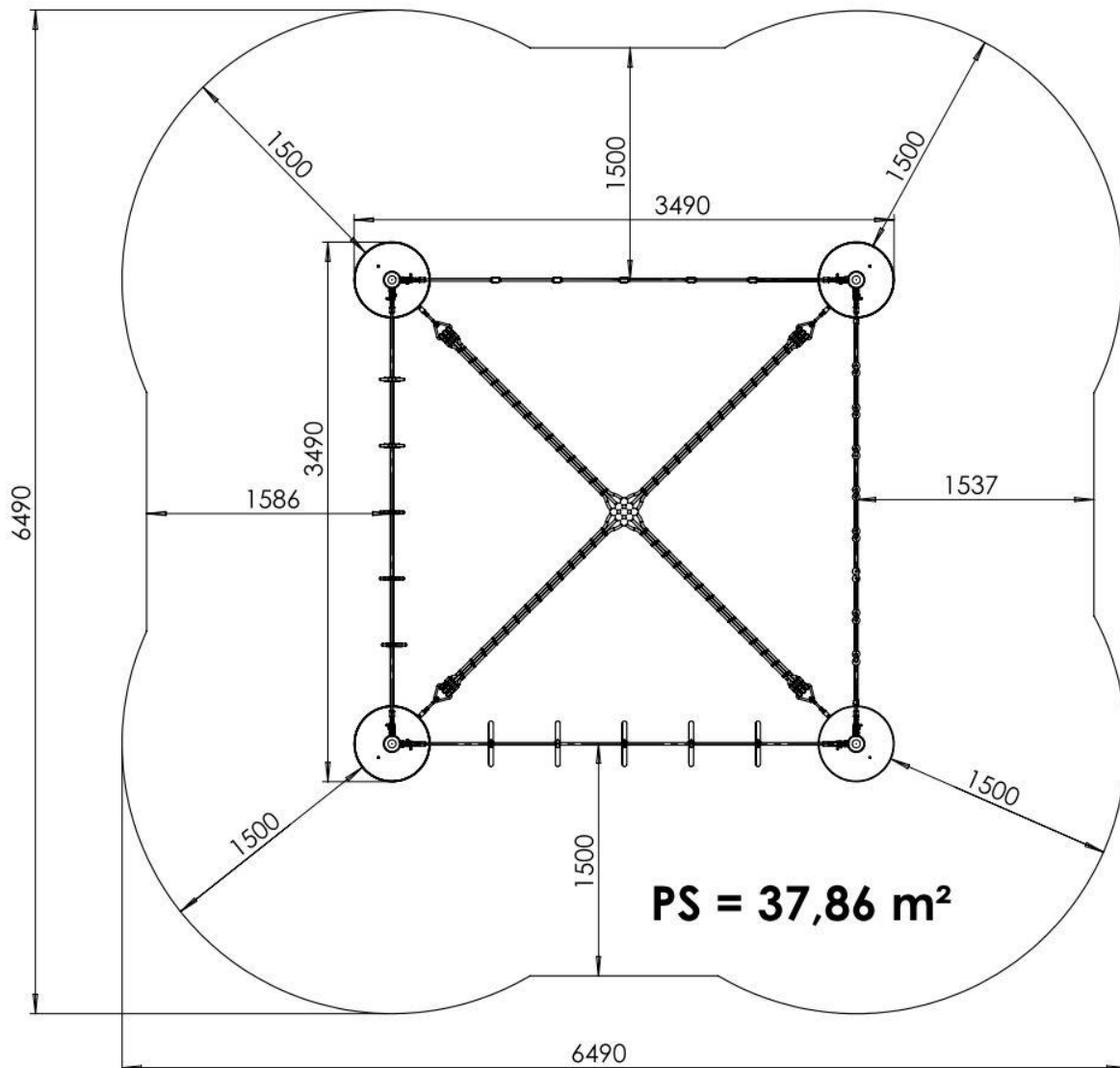
Pos.	Quantity	Symbol
07	1	 <p>AM 3000 mm</p>
08	1	 <p>AM 3000 mm</p>
09	2	 <p>AM 3000 mm</p>
10	4	 <p>Ø 490 mm</p>
11	18	 <p>Ø 101,6 mm</p>
12	12	 <p>4,5 x 25 mm</p>
13	4	 <p>Ø 101,6 mm</p>
14	4	 <p>Ca. 400 x 400 mm (on site / by customer)</p>

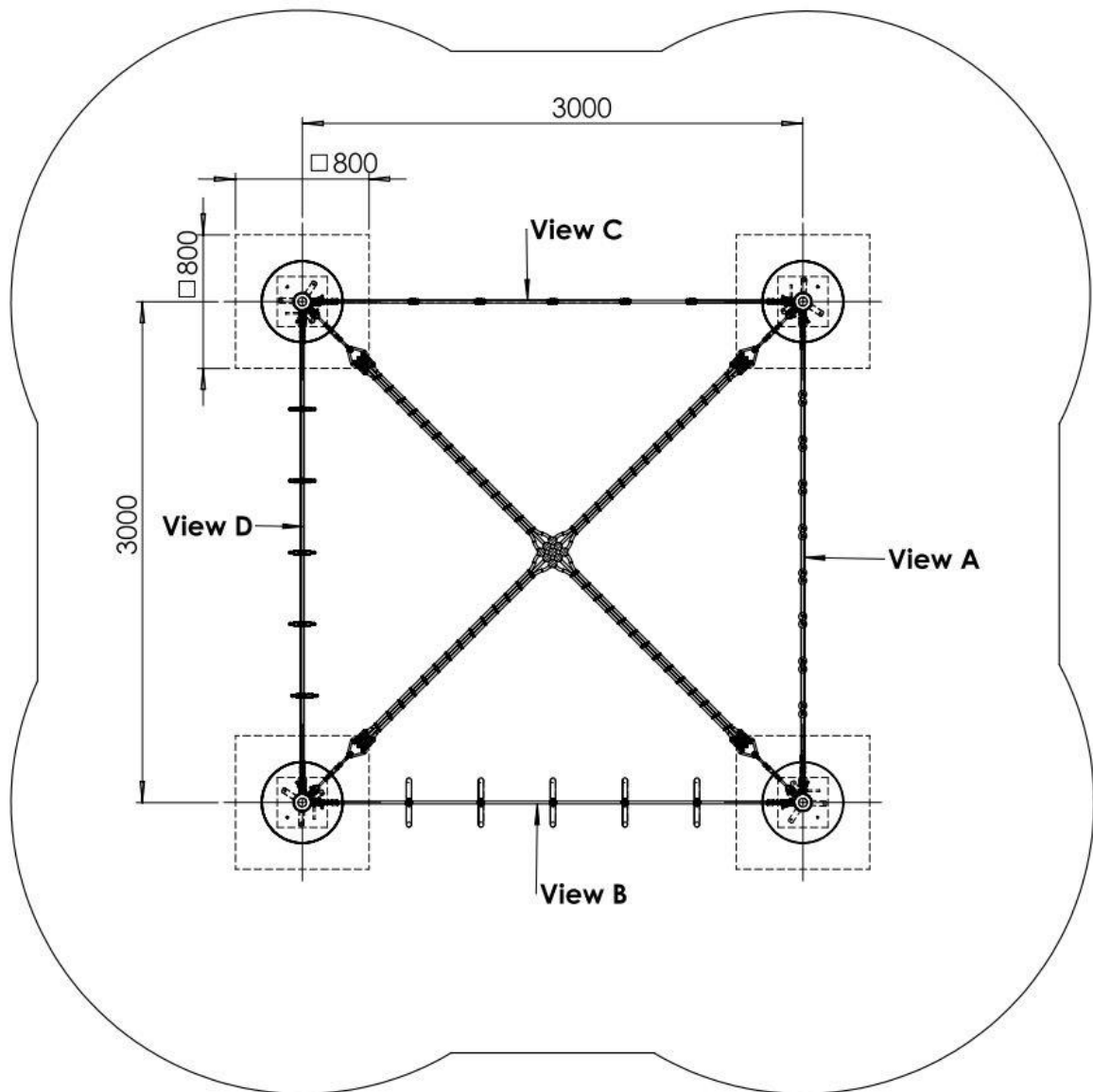
Loctite-Thread locking adhesive!

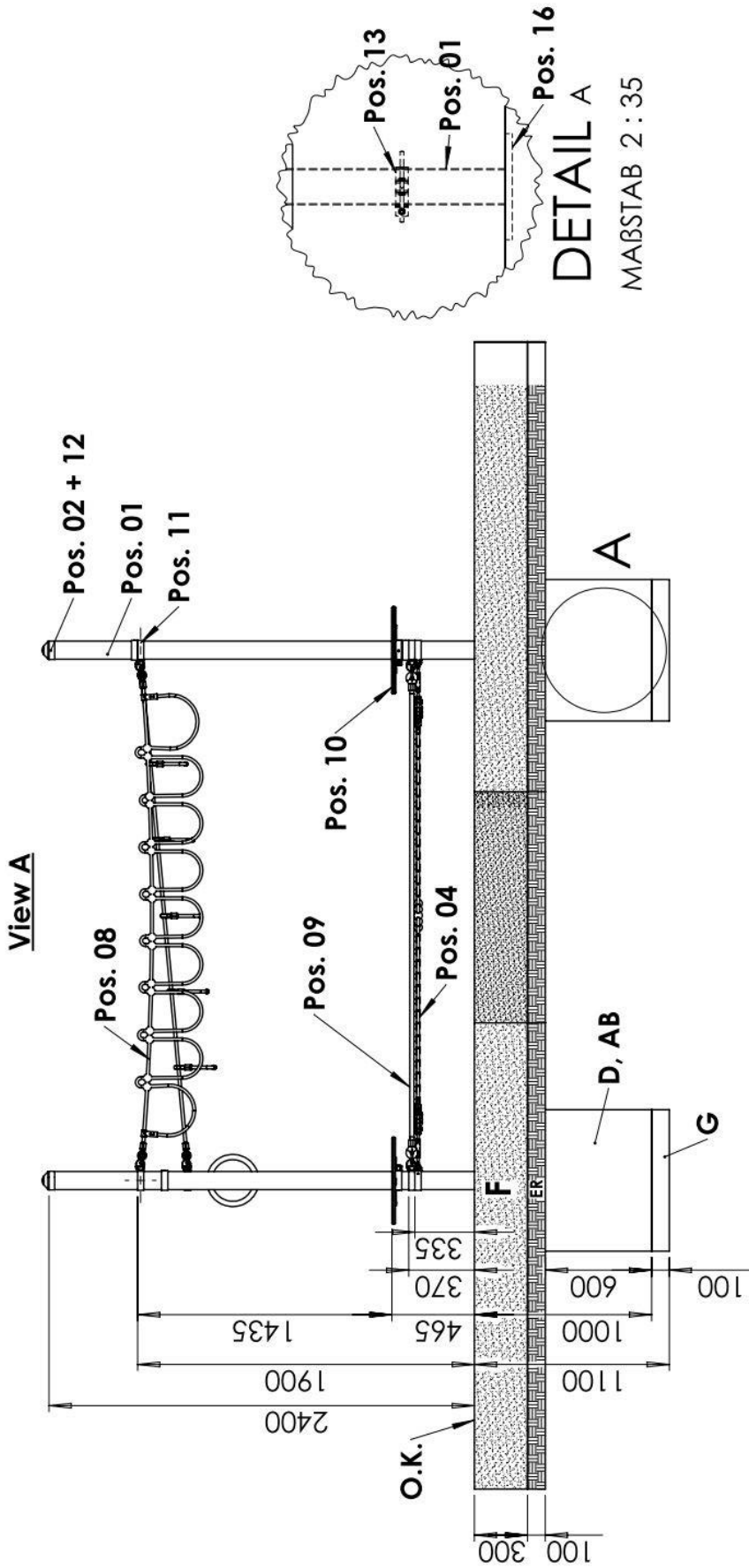


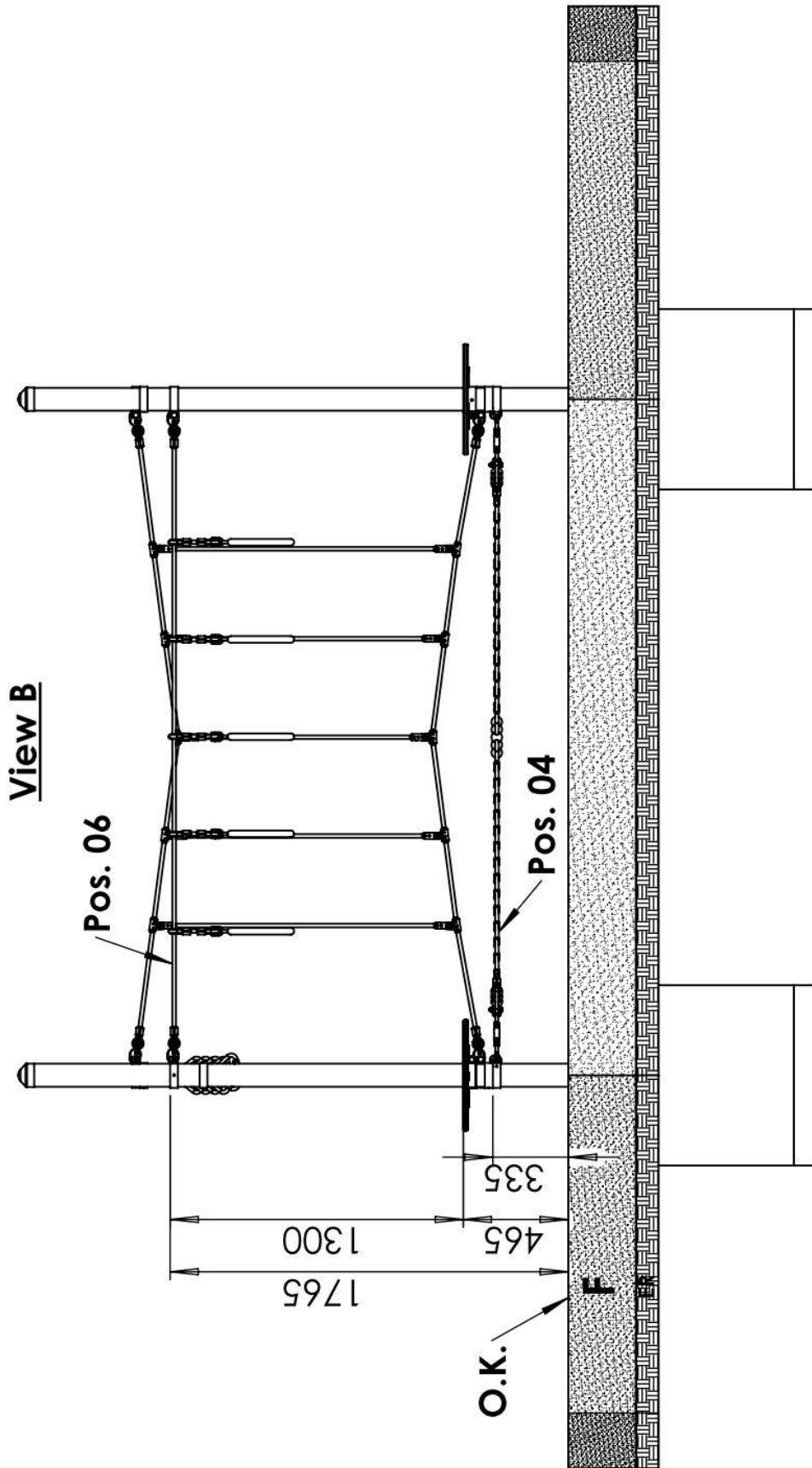
Glue all screws, nuts and sleeves with loctite.
(not less than 5 drops !)
(except for lock nuts)

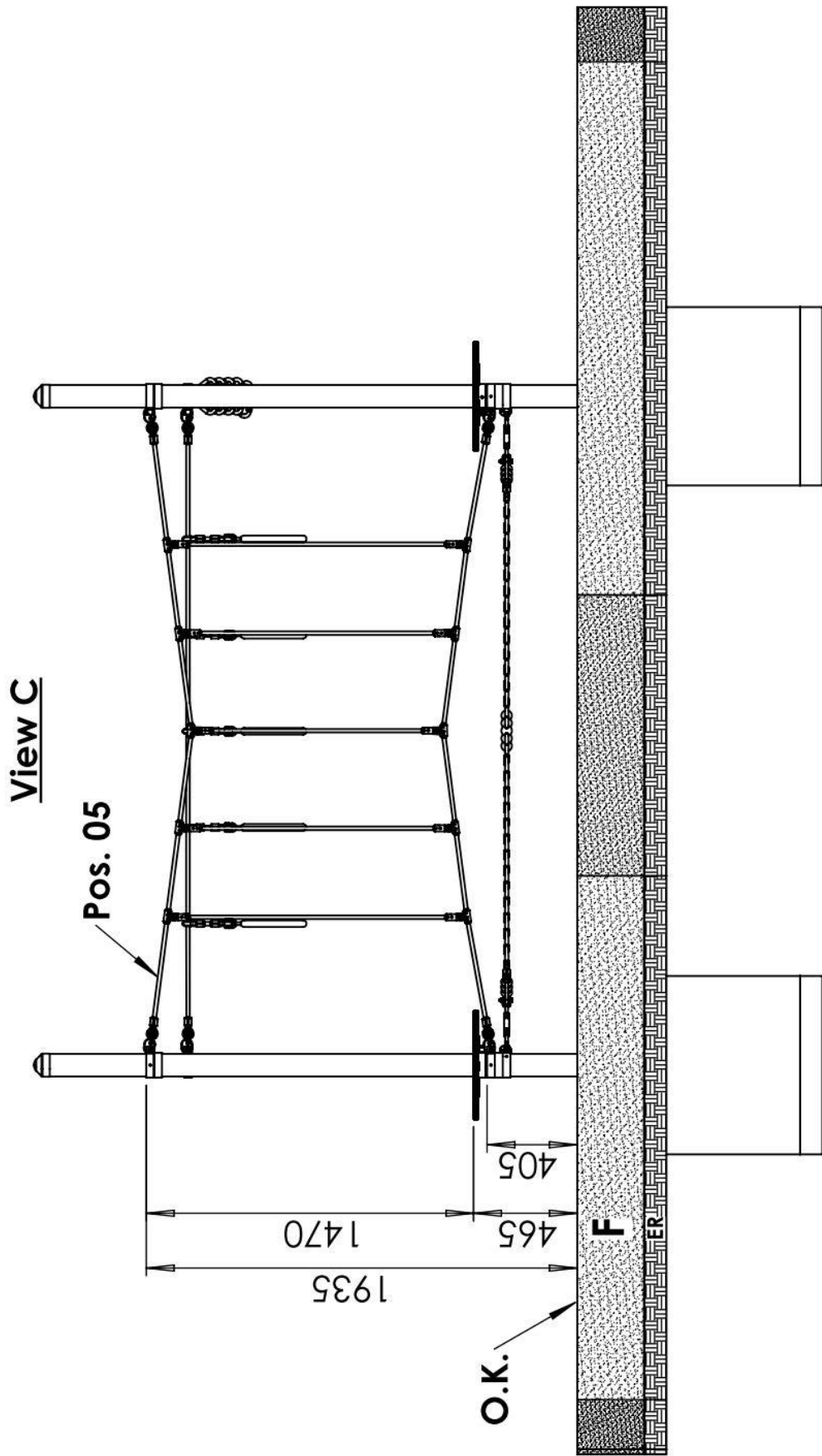
4 Erection instructions

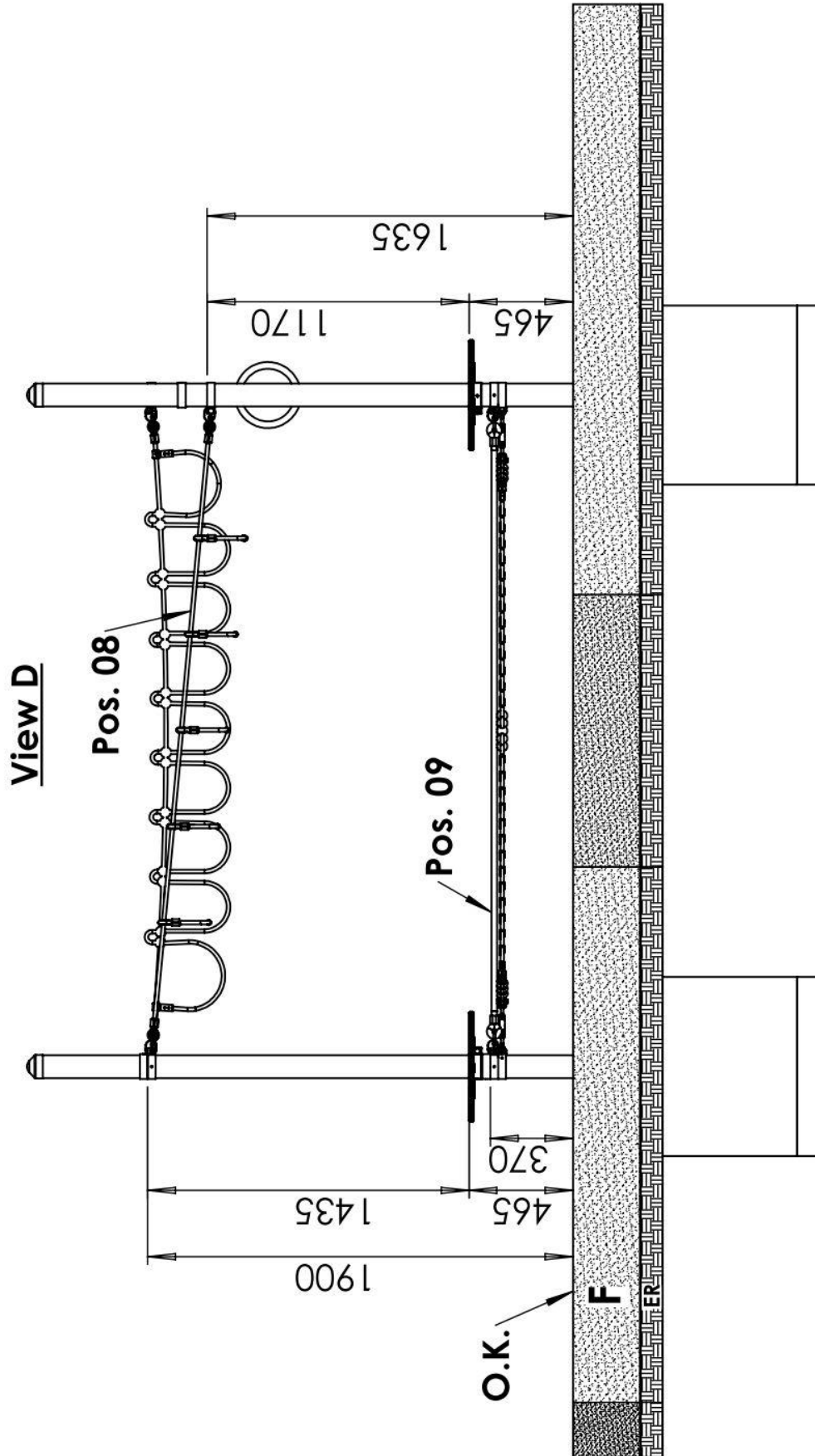












	<u>Abreviations</u>
AB	Minimum legal setting time
AM	Axial dimension
D	Concrete C25/30 (for foundations) Concrete requirement: 1,54 m ³
ER	Ground, fall protection etc. (ground) 100 mm thick
F	Fall protection 300 mm
G	drainage layer 100 mm
O.K	Upper edge of play level
PS	Space requirement including safety zone ~38,15 m ²
R	Radius

5 Post installation checks



If the equipment has not been installed safely, you must ensure that the public is prevented from using it.

5.1 Marking filler depth

- Labelling the posts to show the depth of material provided as fall protection (i.e. loose filler).

5.2 The equipment has not been installed safely in the following cases:

- Installation of equipment is not complete.
- The protective surface has not been installed yet.
- Appropriate maintenance work cannot guarantee operational safety.

5.3 Removal of all assembly aids

- Please make sure that all assembly aids have been removed from the playing area. The equipment must not be approved for use until this check has been carried out.

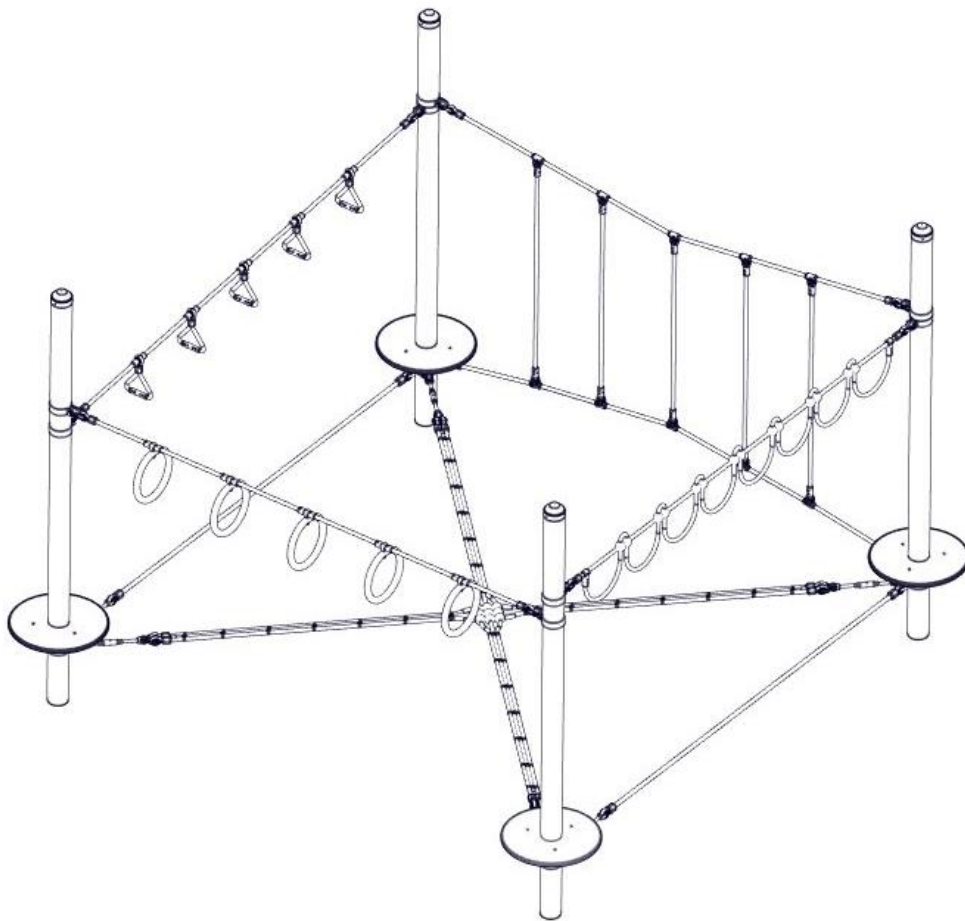
5.4 Information about inspection of the equipment before it is used for the first time

- There are no special inspection requirements to be met before the equipment is used for the first time.

5.5 Retighten bolts

- After one week of play, please retighten all bolts again. Later upon respective maintenance.

B Maintenance Instructions
Slack Master Combination 2
Art.4591-72



6 Introduction Maintenance

6.1 General informations

This equipment should be installed, inspected, maintained and operated in accordance with EN 1176-7 guidelines.



Notice

Please note: Providing any necessary repairs are carried out, a piece of play equipment that is inspected regularly cannot become so damaged that it is dangerous.

Any spare parts which may be required can be obtained directly from your supplier or from Fa. Huck Seiltechnik GmbH

Adress: Huck Seiltechnik GmbH
Dillerberg 3
D-35614 Aßlar/Berghausen
Tel. +49 6443 83 11-0
Fax +49 6443 83 11-79



This equipment should only be assembled, maintained and repaired by persons with the necessary expertise.

A copy of the inspection record should be given to the operator, who must confirm receipt.

**This maintenance instruction is based on the standard
“EN 1176-1”.**

7 General maintenance information

7.1 Maintenance intervals

Maintenance intervals are based on average use. Please note that more frequent inspections and/or maintenance are required if the play equipment is subject to intensive use.

7.2 Inspection frequency

The frequency of inspections must be based on actual use. Factors that affect frequency include vandalism, location (e.g. coastal proximity), air pollution and the age of the equipment.

7.3 Maintenance products and procedures

All nuts and bolts are hot-dip galvanised or stainless steel. One of the characteristics of stainless steel is that uncontrolled cold welding may occur when the nuts are tightened. To prevent this, it is necessary to spray the nuts and bolts with Teflon spray or another similar lubricant.

7.4 Spare parts

All spare parts must conform to the manufacturer's specifications.

7.5 Identifying spare parts

All spare parts are listed in the parts list. The parts list follows the installation requirements.

7.6 Special instructions for the disposal of individual equipment components

No special instructions are necessary.

7.7 Special measures during the break-in period

No later than 2 weeks after assembly, all screwed connections should be checked and tightened if necessary.

7.8 Maintenance of protective surfaces

Surfaces providing fall protection must also be maintained regularly. It is particularly important to maintain the correct level of loose surface material and add more if necessary.

7.9 Faults



Damages must be repaired as soon as they are detected. If serious defects that affect the safety cannot be repaired straight away, the playground item must be blocked with immediate effect.

7.10 Loose screws



Loose screws always cause quality problems and put safety at risk. Therefore, loose screws should always be tightened and checks carried out to ensure that there are no missing screws.

7.11 Preventing equipment use

Use of the equipment should be prevented in the event of incomplete installation, disassembly, maintenance, repairs and faults.

7.12 Claims/liability for faults (steel poles)

Steel posts and footings are covered by our guarantee if regular maintenance is carried out and recorded in writing.

Our general terms and conditions apply. Maintenance of steel poles first takes place after 3 years. The steel posts must be excavated down to the concrete foundations and checked for corrosion.

Zinc paint should be applied to any corroded areas and scratches.

Check ropes for abrasion, replace ropes where coating is damaged down the Steel inlet.

8 Maintenance timetable

8.1 Special advices

8.1.1 Maintenance interval

We strongly advise you to carry out inspections and maintenance work within the specified periods as use of the equipment, the weather and malicious vandalism cause wear and tear that compromises the safety and function of the equipment.

8.1.2 Maintenance intervals in the event of intensive use

Please note that more frequent inspections and/or maintenance are required if the play equipment is subject to intensive use.

8.1.3 Faults that compromise safety



Notice

In the event of a fault that compromises safety, quick action must be taken. This may involve repairing it immediately or shutting down and dismantling the equipment.

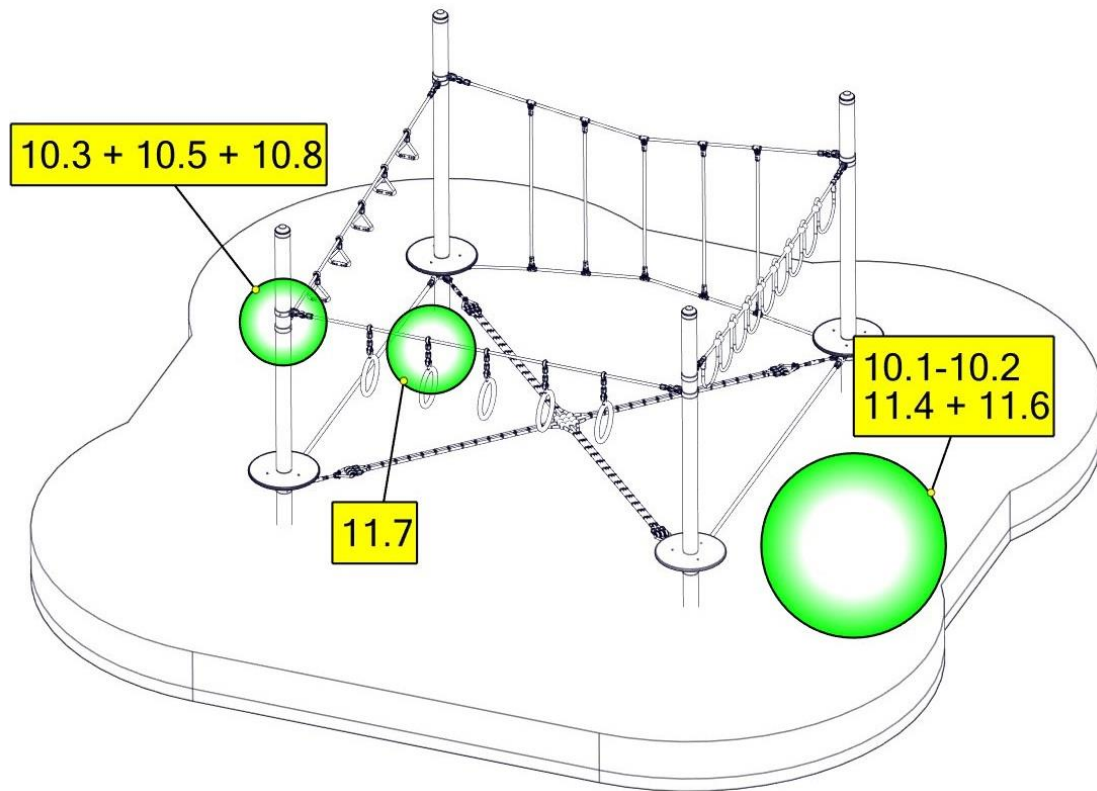
8.1.4 Faults that compromise function



Notice

Faults that compromise function should also be repaired immediately. Such faults lower the value of the equipment to the user and encourage malicious vandalism, which may render the equipment less safe. Any damage should also be repaired immediately.

9 Regular maintenance



10 Monthly maintenance

- 10.1 Check the spaces between the equipment and the ground (clearance and height of fall).**
- 10.2 Check the ground surface of fall protection for hard objects and loose foundations.**
- 10.3 Check all connecting elements and fittings for wear and tear and tighten if necessary. Replace damaged or missing parts.**
- 10.4 Check that moving metal parts (joints, springs, etc.) move smoothly and are not worn. Replace if necessary. It is not necessary to lubricate joints as we only use maintenance-free metal roller bearings.**
- 10.5 Check all attachments such as chains, ropes, nets, etc. for damage and replace if necessary.**
- 10.6 Check rubber parts, sleeves, etc. for wear and tear or damage and replace if necessary.**
- 10.7 If necessary, remove excess padding material from the post footings due to danger of rotting.**
- 10.8 Check the surface of wooden parts for damage caused by the weather or external influences and mould. Repair or replace if necessary.**
- 10.9 Check the surface of plastic and metal parts, e.g. slides, for damage and replace if necessary.**

11 Quarterly maintenance

- 11.1 Detailed inspection of the operation and stability of the equipment paying particular attention to any wear and tear.**
- 11.2 Tighten all forms of attachment.**
- 11.3 Repaint and retreat surfaces.**
- 11.4 Maintenance of fall protection surfaces.**
- 11.5 Lubrication of joints.**
- 11.6 Check height of fall protection material and top up with loose filler if necessary. If the posts are labelled, top up to the mark.**
- 11.7 Retighten all bolts.**

12 Half yearly maintenance

- 12.1 The stability of supporting posts, supports, foundations etc. has to be checked. The safety level of the entire system has to be checked after repairs have been carried out or additional system components have been installed or replaced.
-



Attention

Annual Maintenance

13 Annual maintenance

- 13.1 Ascertaining that the equipment, foundations and surfaces are safe for operation.
- 13.2 In particular, the equipment should be checked for decay and corrosion. It may be necessary to dig out or excavate certain components in order to do so. Zinc paint should be applied to corroded areas and scratches.
-



Attention

The equipment must be inspected by someone **with the necessary expertise** in strict compliance with the instructions issued by Huck Seiltechnik GmbH.

A copy of the inspection record should be given to the operator, who must confirm receipt.

14 Maintenance printout

Name of item: Slack Master Combination 2 _____ / Art. No. 4591-72 _____

Location: _____

Customer or operator: _____
 (Town, Town council, Kindergarten)

Date of inspection	Inspector	O.K.	Accessible	Barriered	Defects	Repaired by	Date

Please copy and return once a year after main inspection has been carried out to the manufacturer by Telefax +49(0)6443/ 83 11 79!
Place the confirmation form in the play equipment files.

15 Hand over document



After the installation of the equipment pass the installation and maintenance documents to the operator. The operator has to receive the hand over documents. The complete filled and signed hand over document should be sent to the supplier.

Art.-No.: 4591-72

Type of item: Slack Master Combination 2

Serial number: _____

Customer or operator (Town, Town council, Kindergarten, etc.):

Competent person in charge:

Installation company (address):

Responsible assistant (assembler):

Received the complete assembly instructions, maintenance instructions and maintenance printout .

(Signature of operator) (Signature of installation company)
(Stamp)

Date: _____